

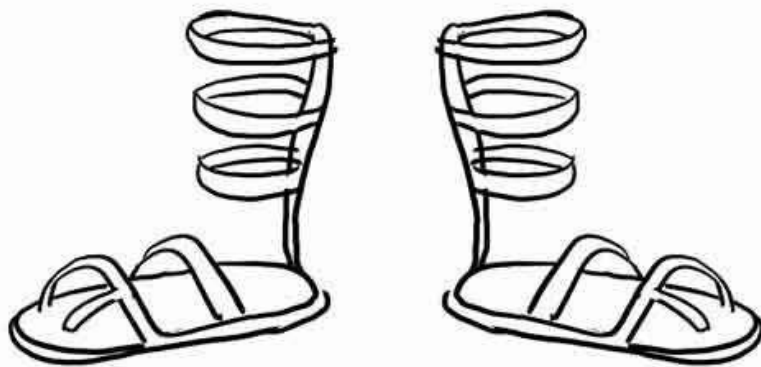

"put on the
Full
ARMOR
of
GOD,
so that
you can
take
your
stand
against the
devil's
schemes."
Ephesians 6:10
(see Ephesians
6:10-17)

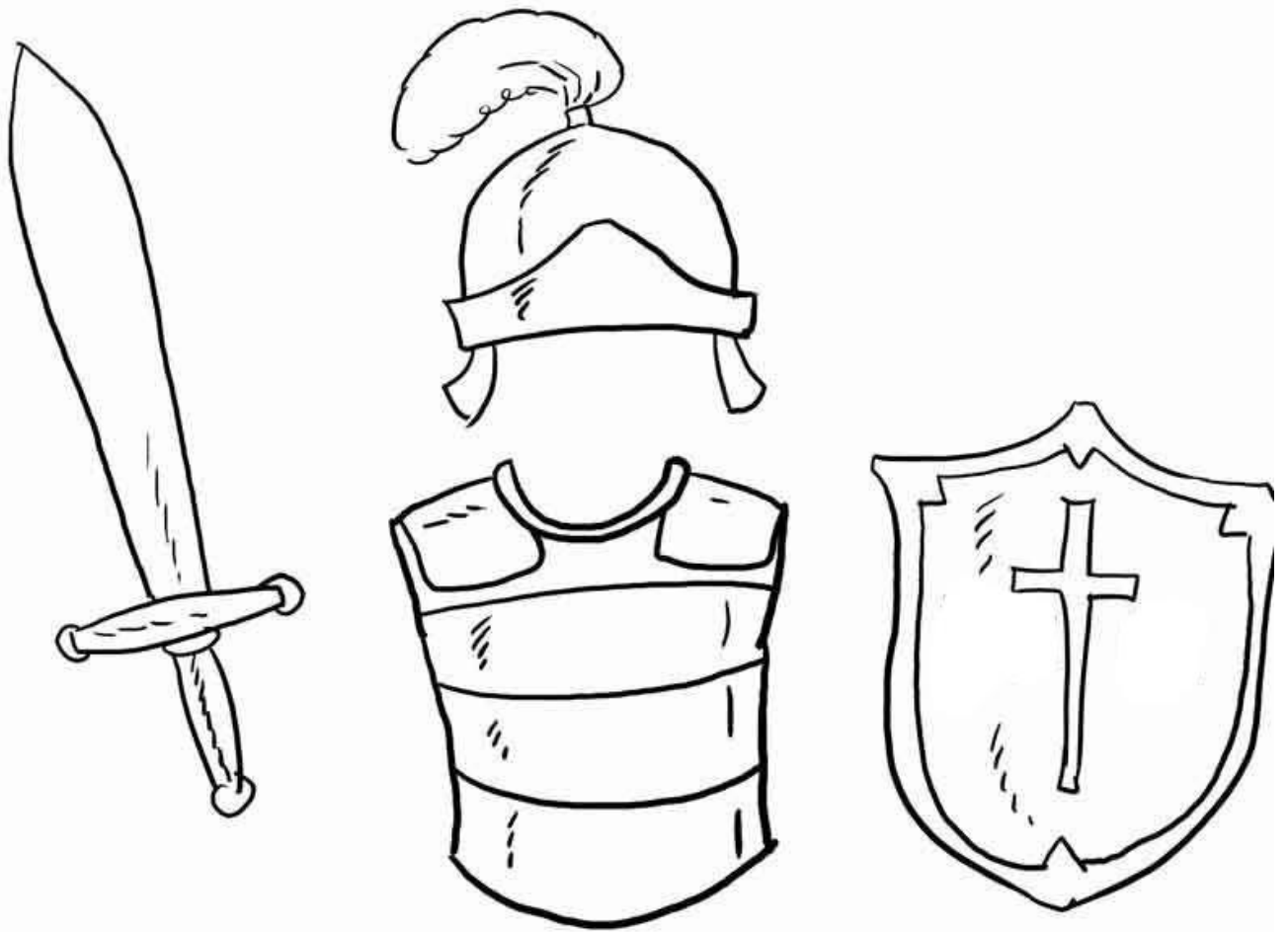

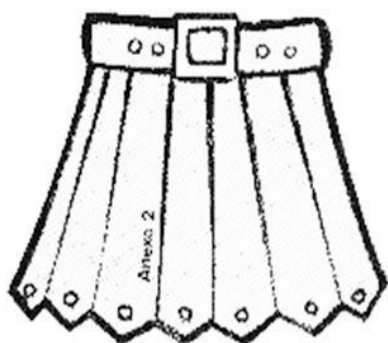

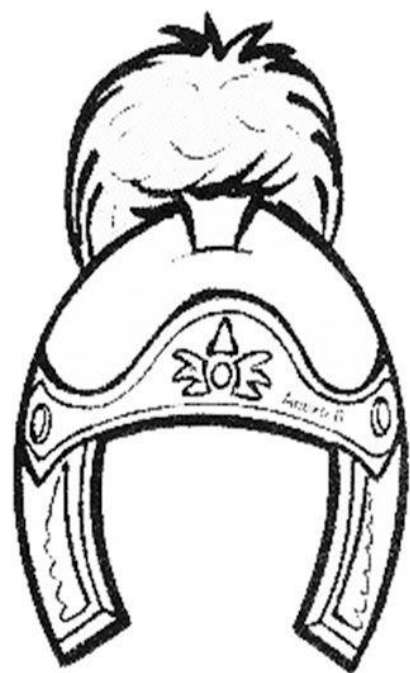

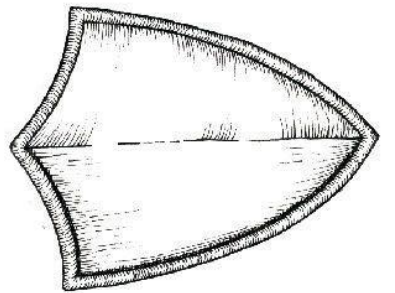
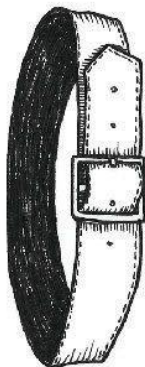
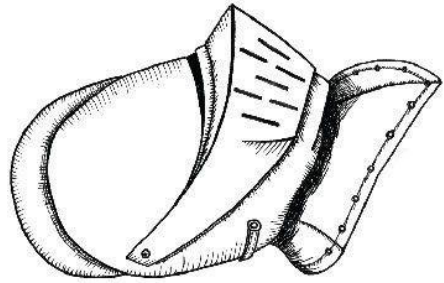
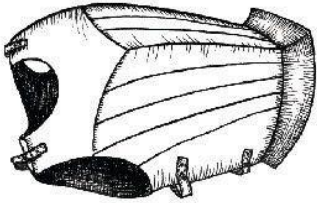
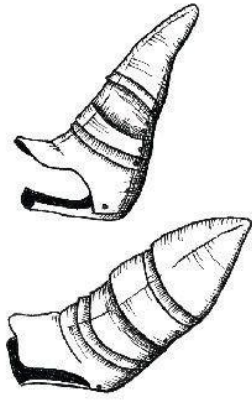
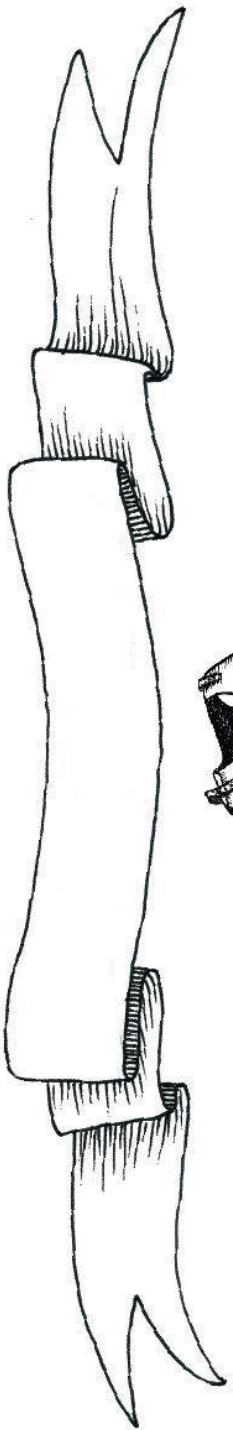

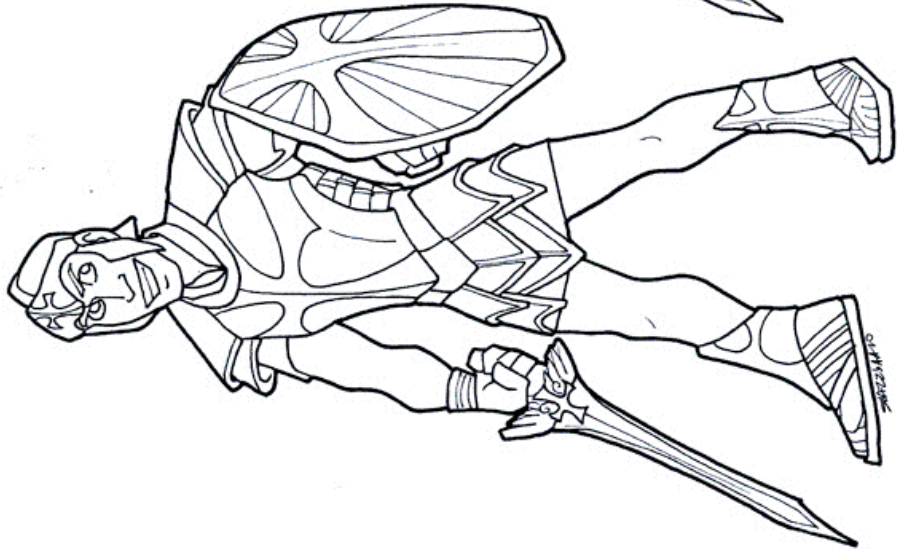
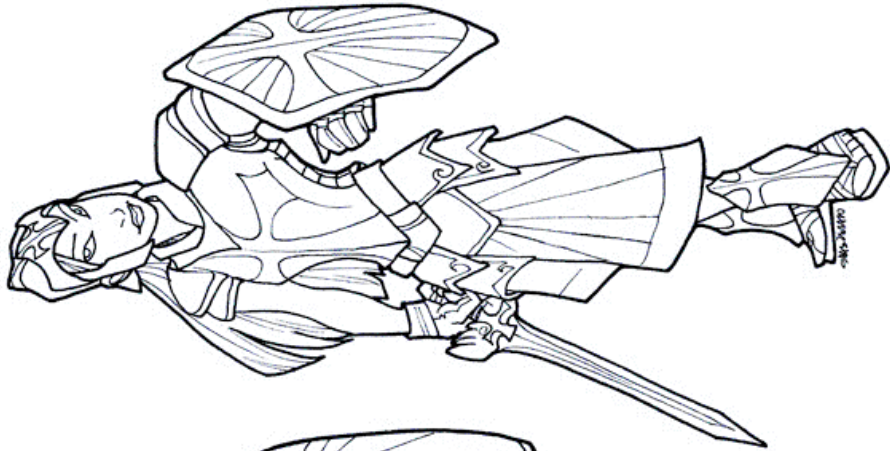
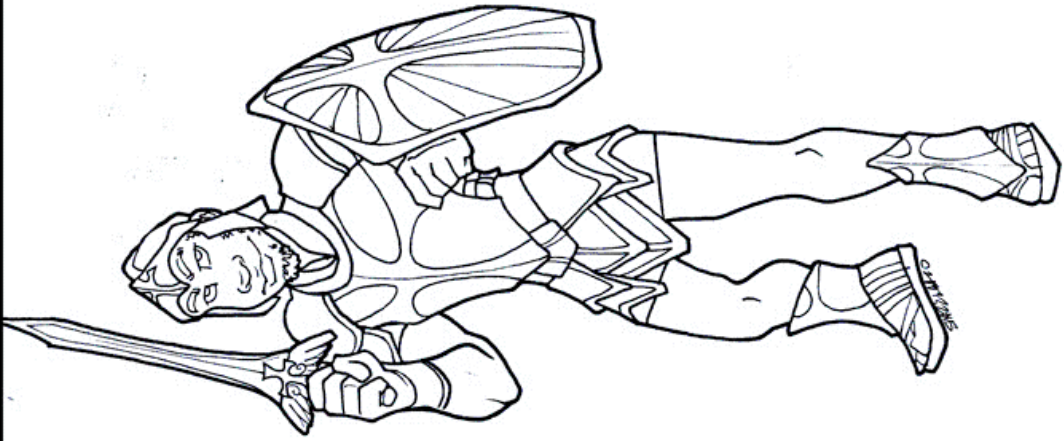
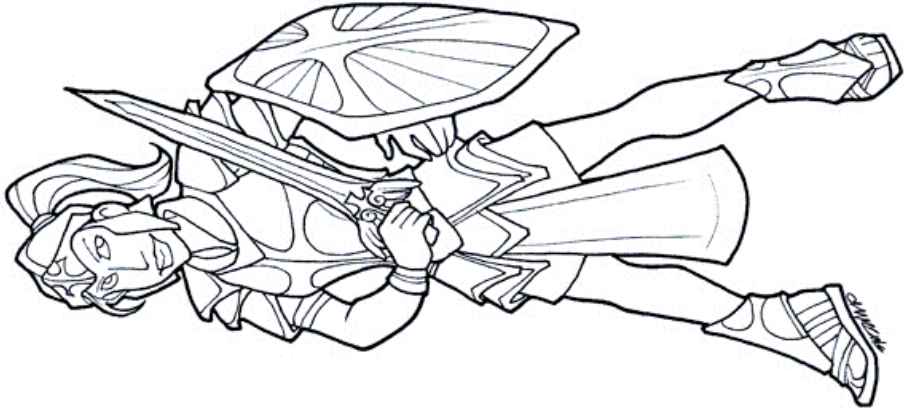

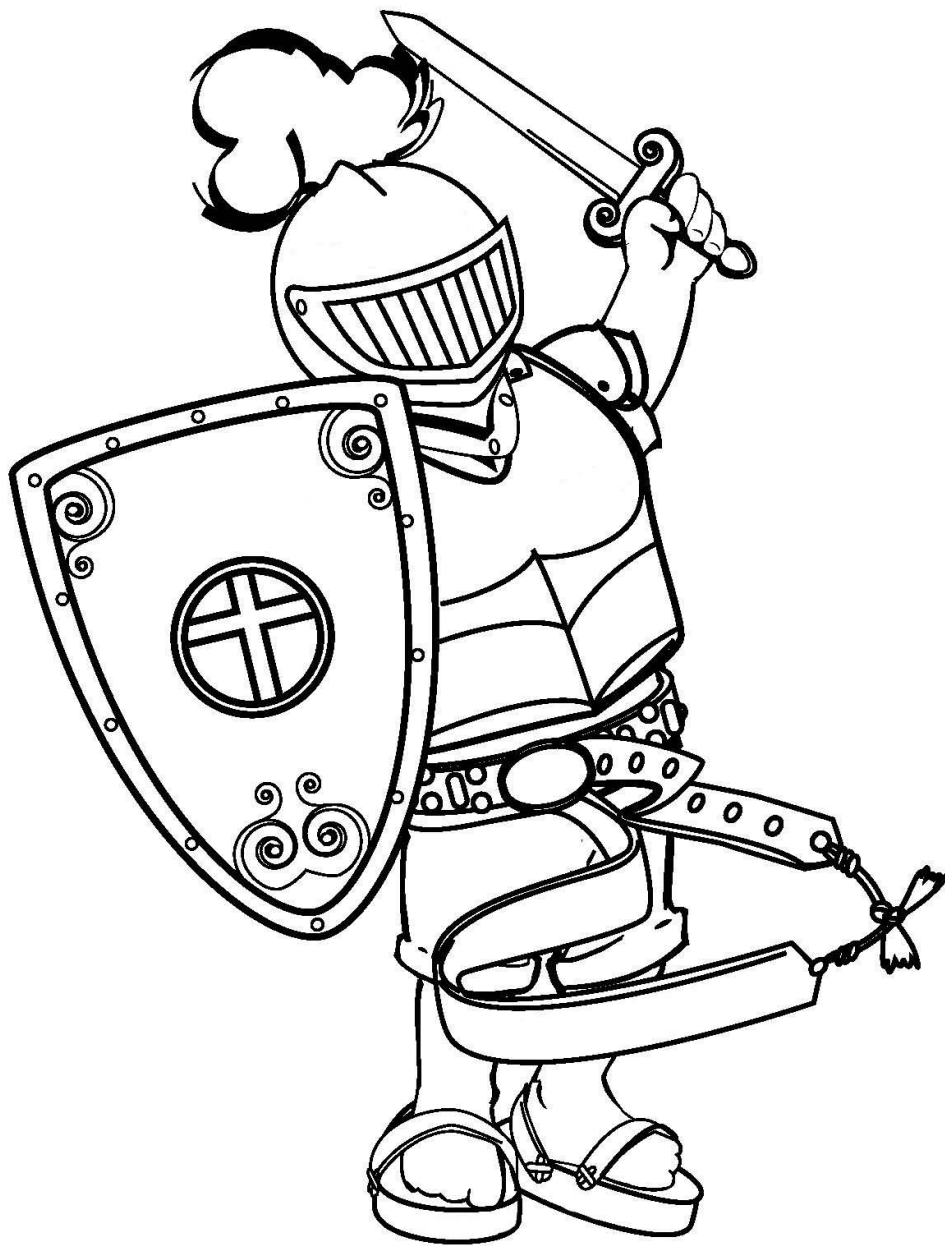

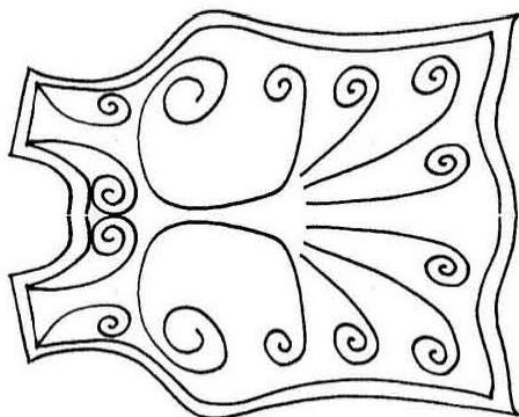
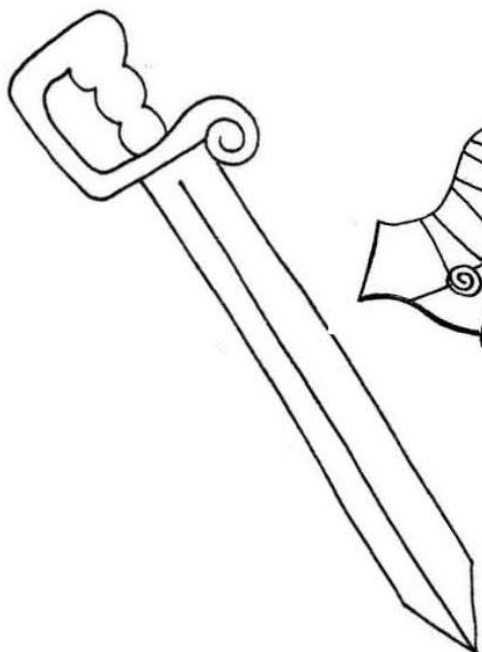
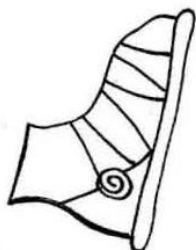
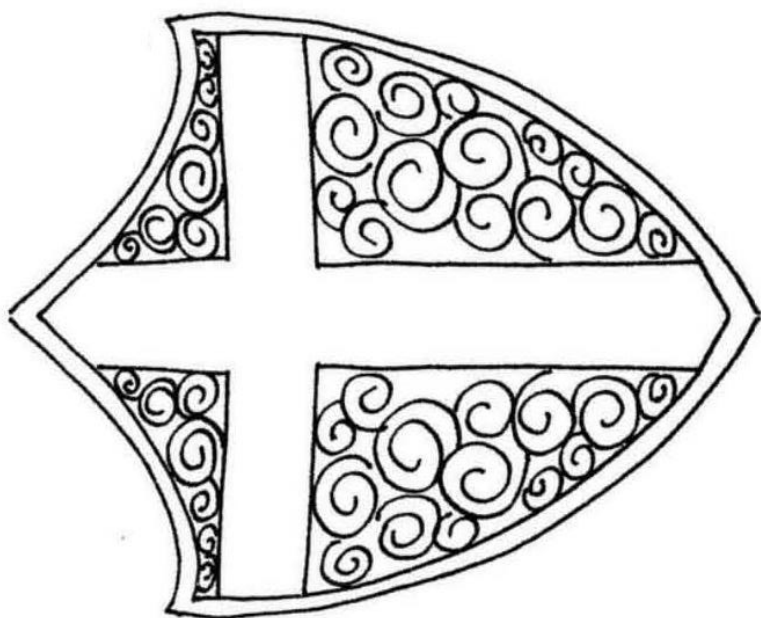
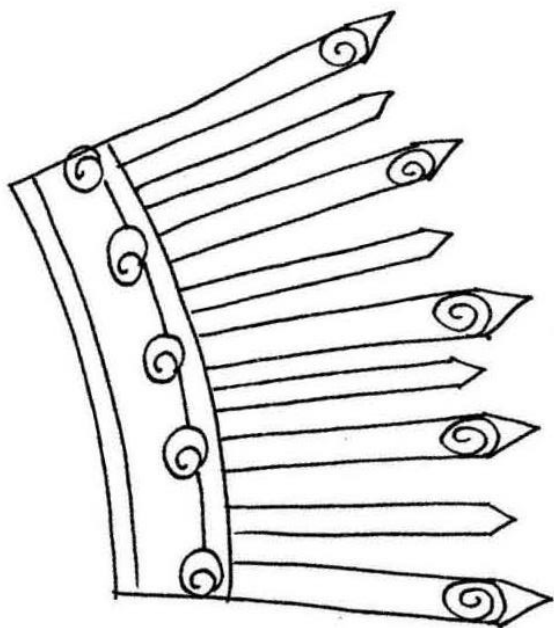
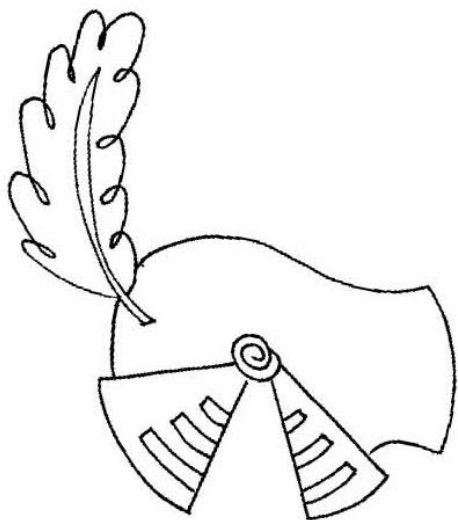



















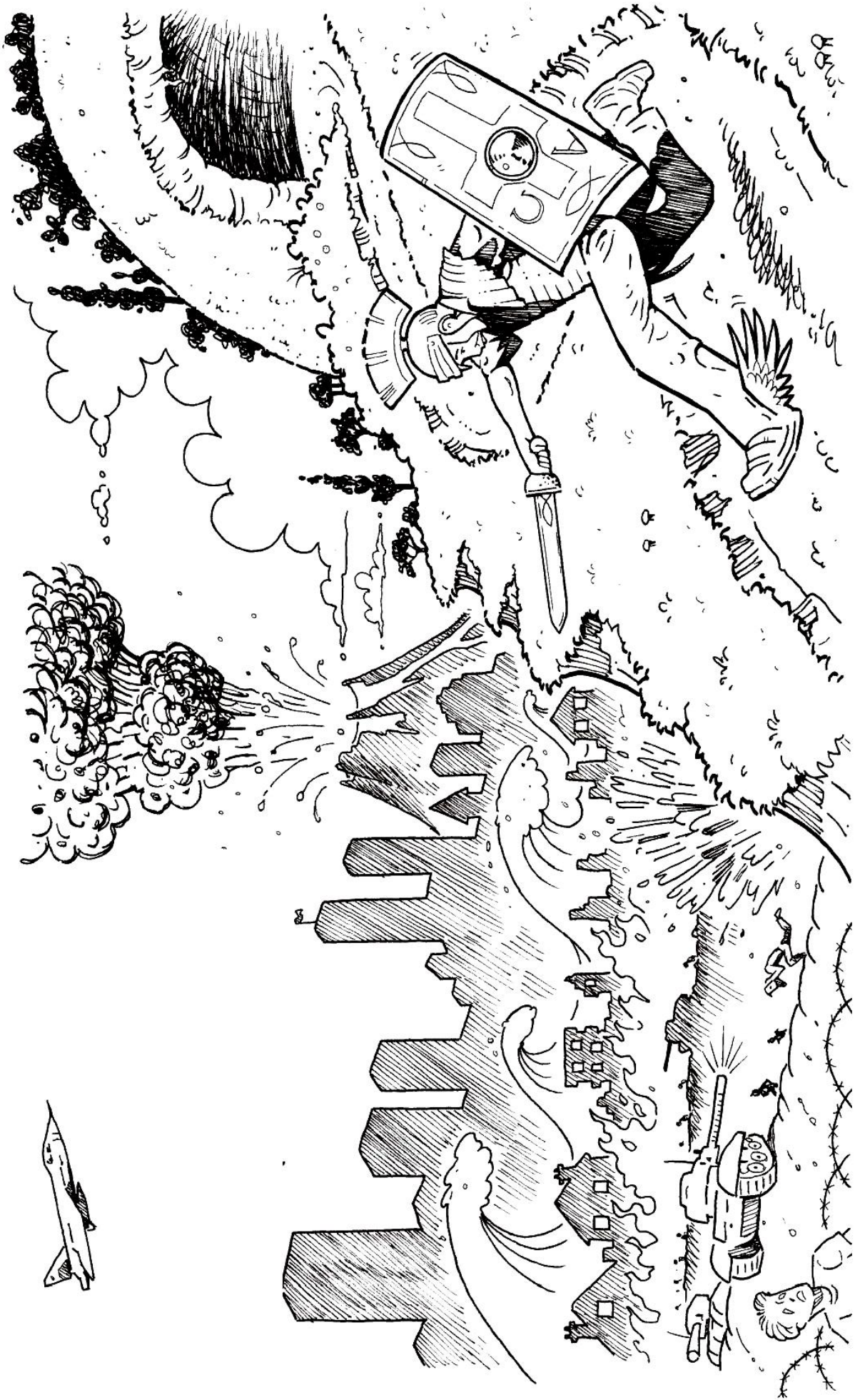

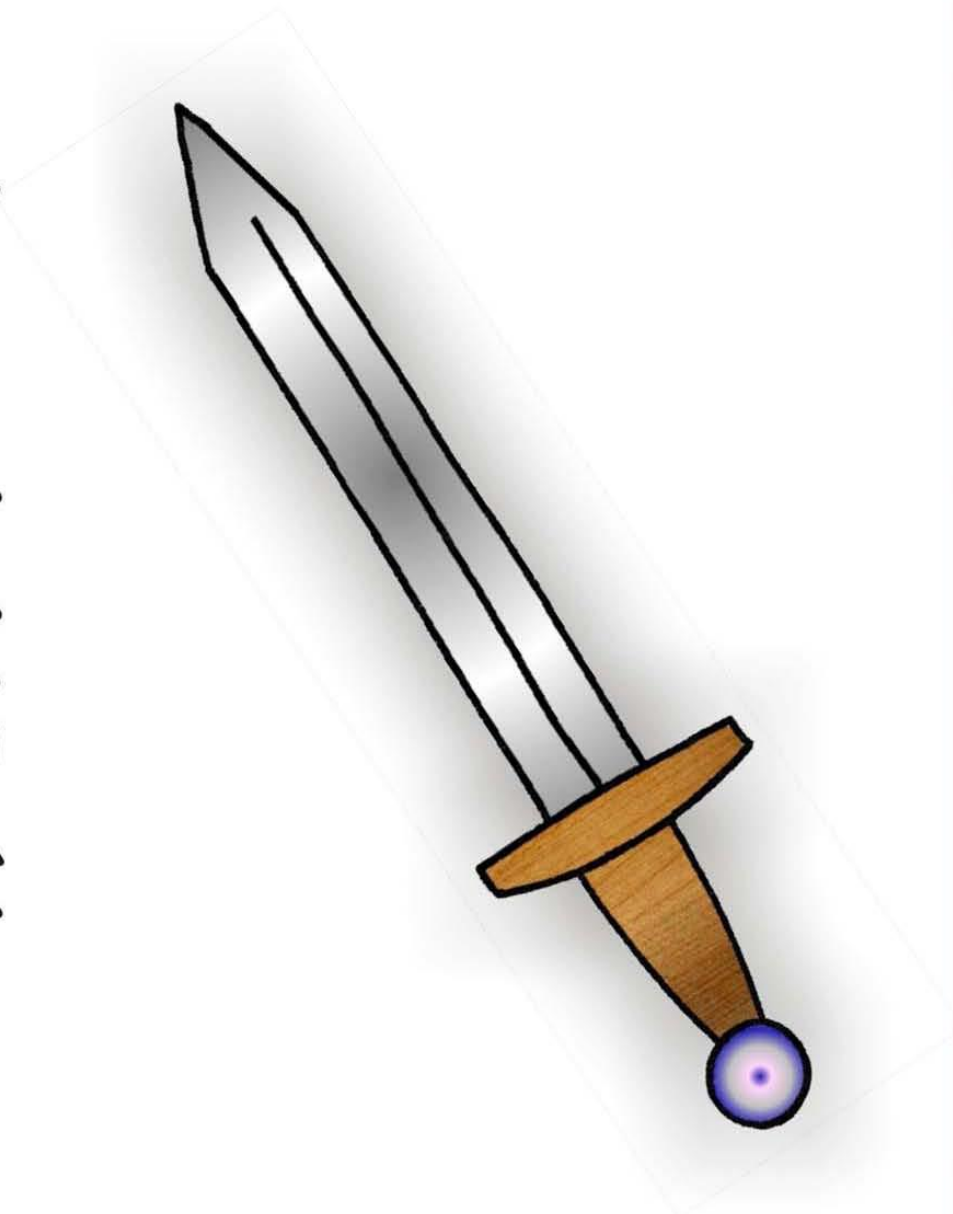

La espada del Espíritu
Efesios 6:17

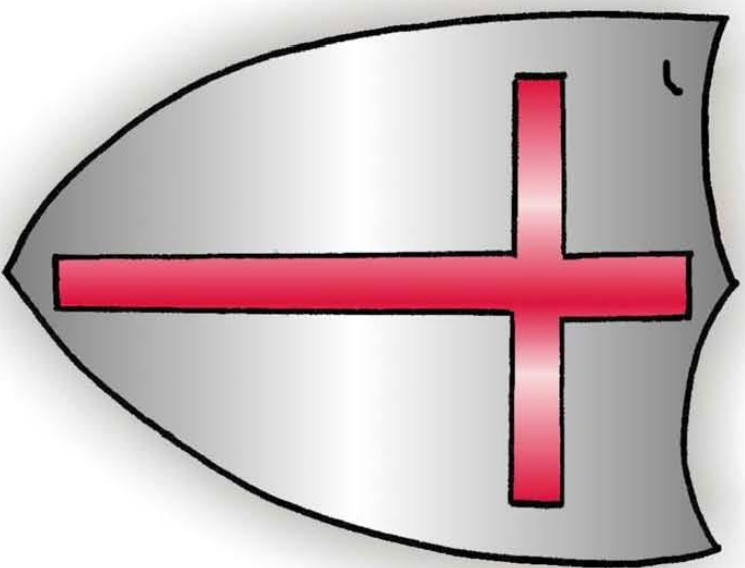

El escudo de la fe

Efesios 6:16

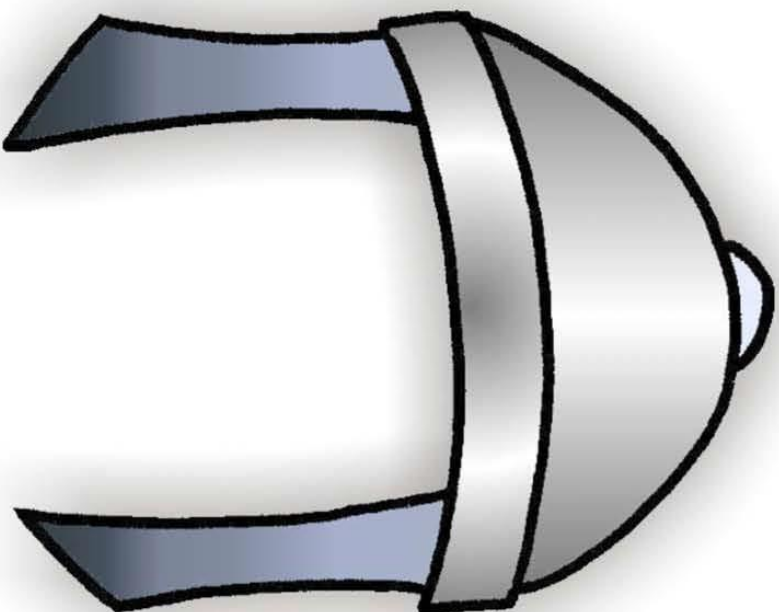

El yelmo de la salvación

Efesios 6:17

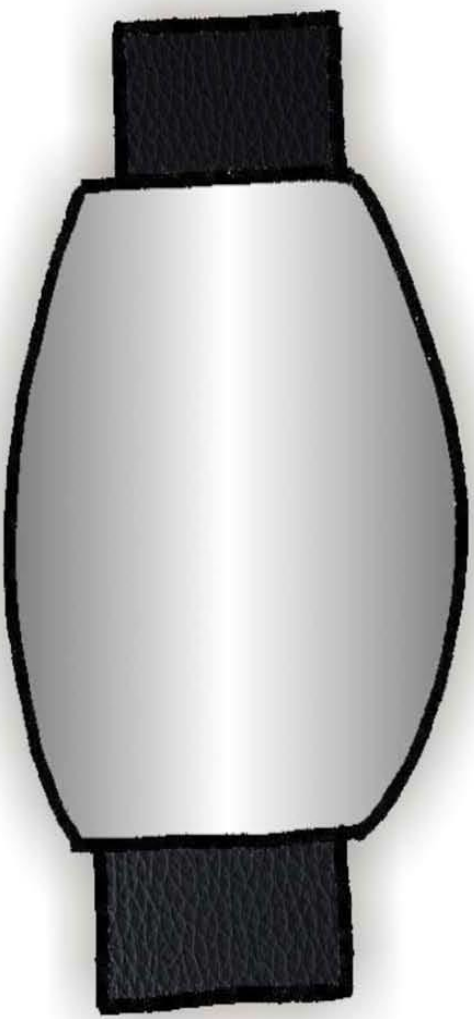

El cinturón de la verdad

Efesios 6:14

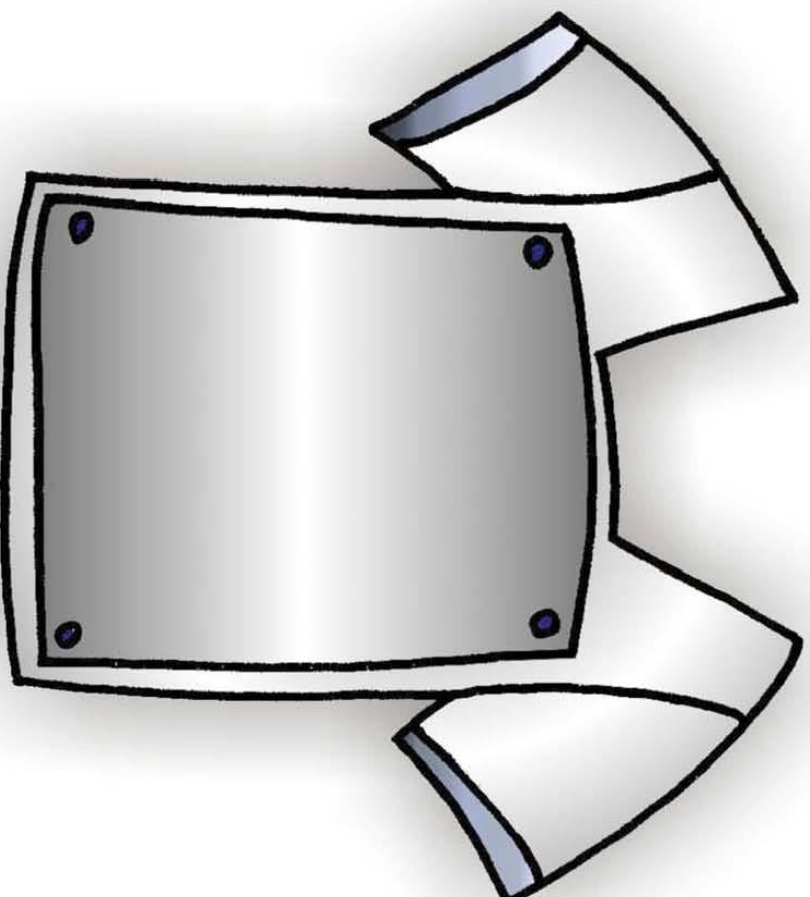

La coraza de justicia
Efesios 6:14

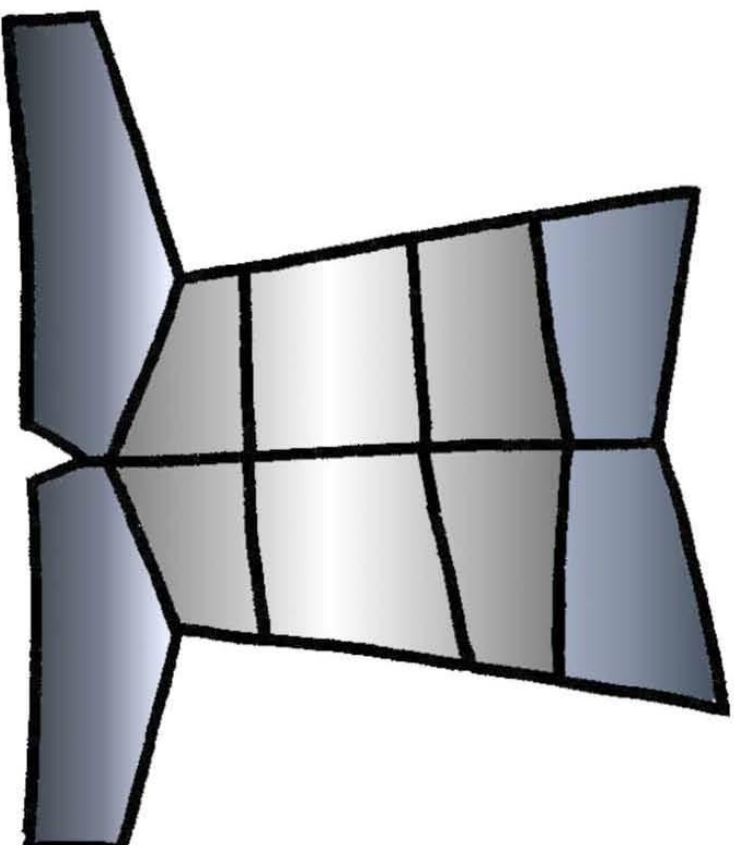

**Apresto del evangelio
de la paz
Efesios 6:15**

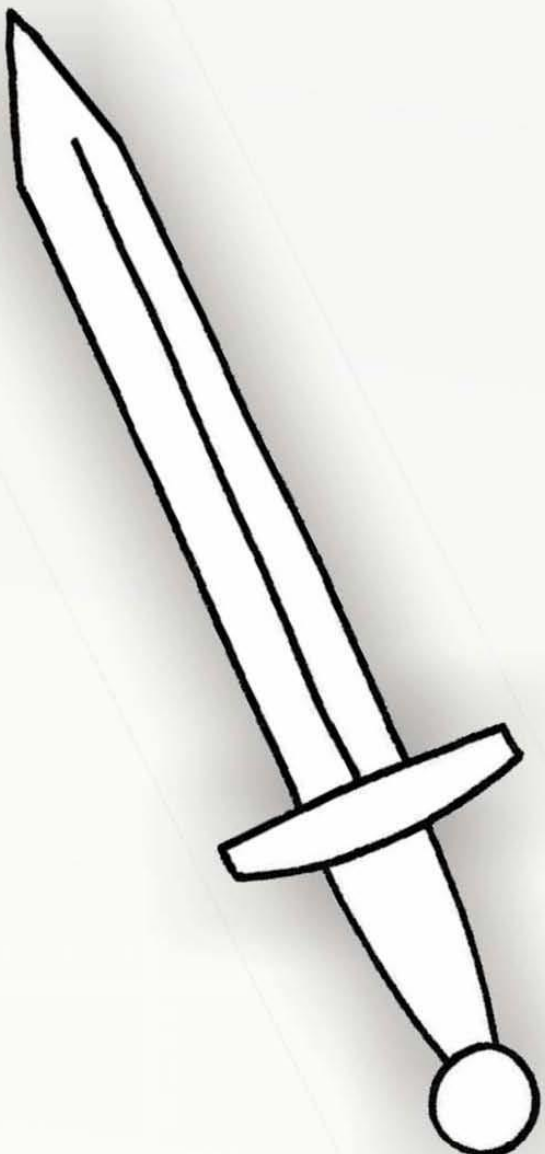

La espada del Espíritu
Efesios 6:17

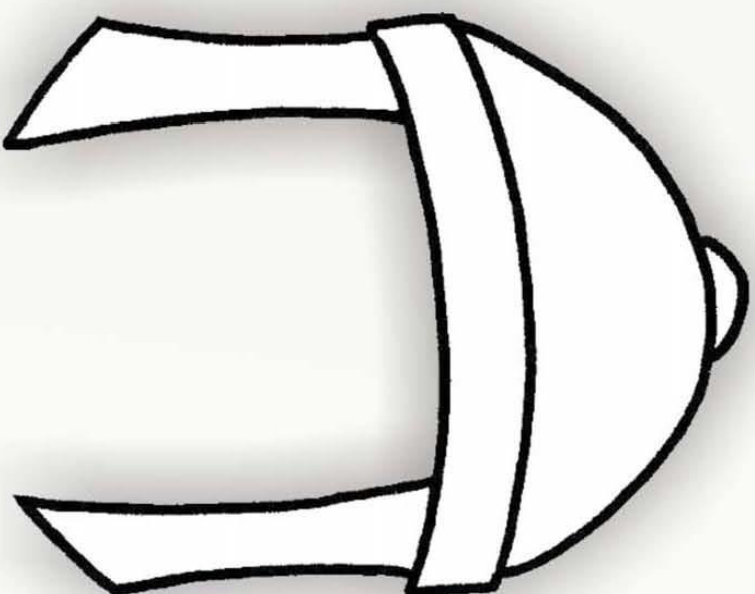

El yelmo de la salvación
Efesios 6:17

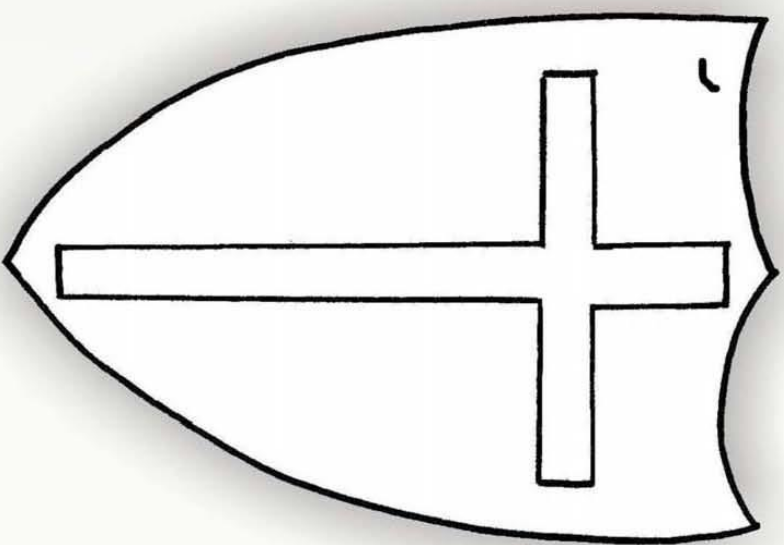

El escudo de la fe
Efesios 6:16

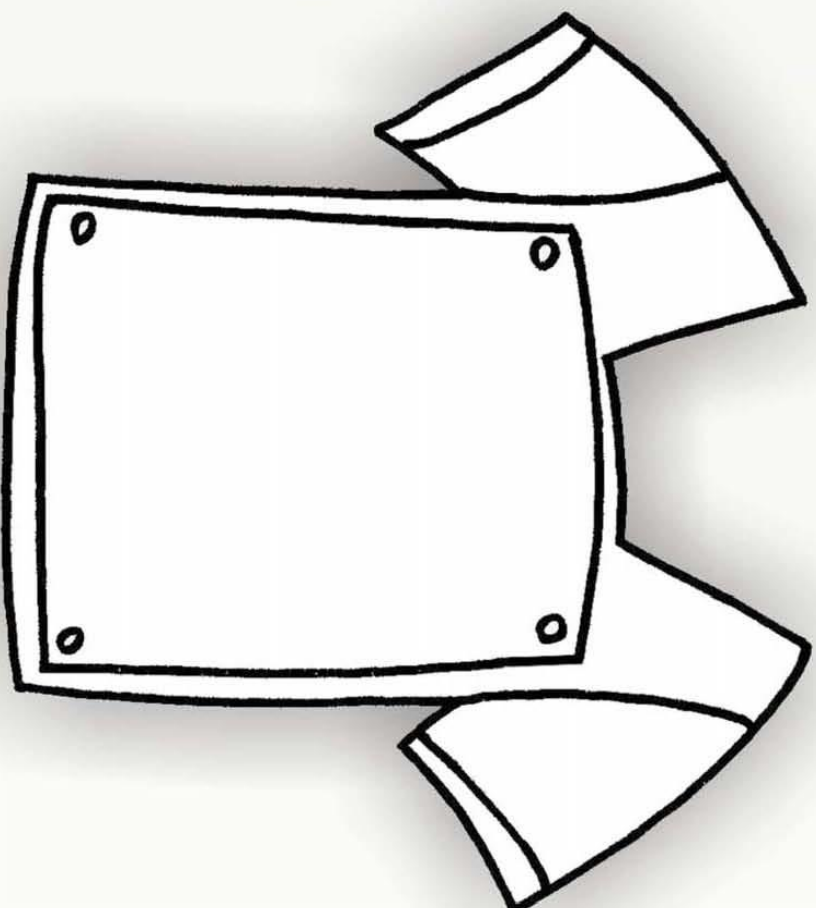

La coraza de justicia
Efesios 6:14

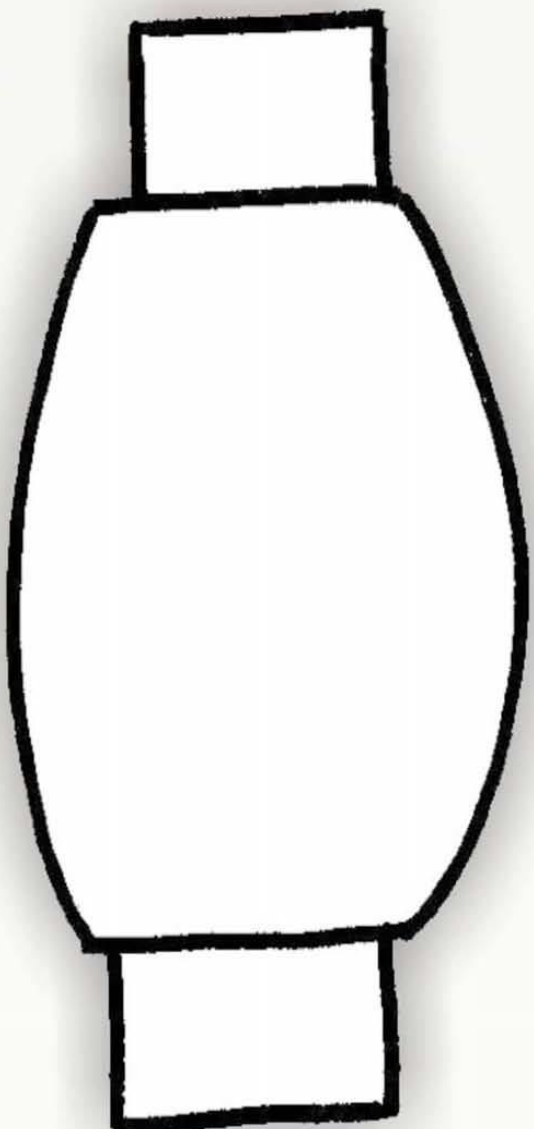

El cinturón de la verdad
Efesios 6:14

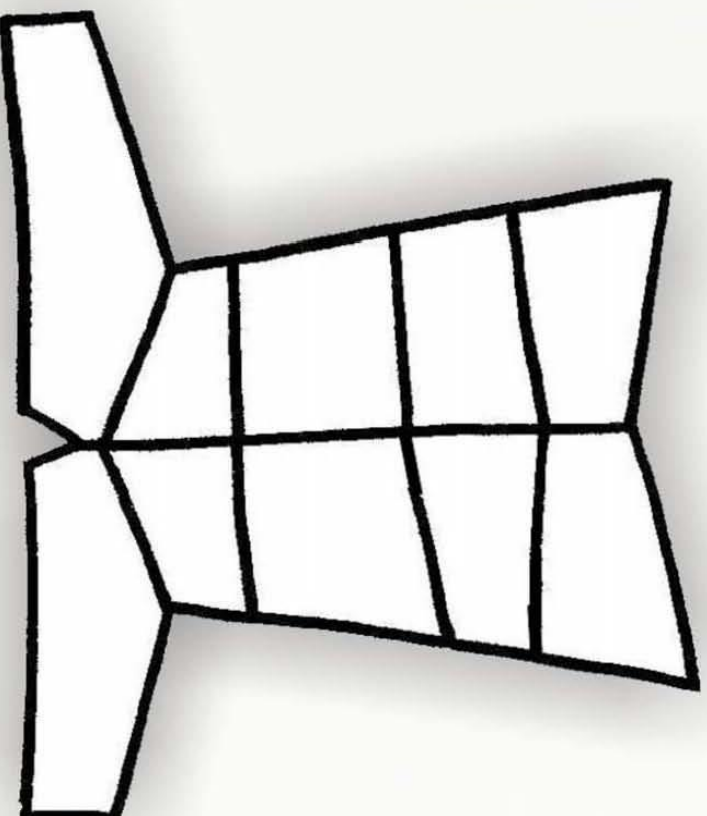

**Calzado del evangelio
de la paz
Efesios 6:15**

PONTE TODA LA ARMADURA DE DIOS

Colorea al soldado romano y luego lee Efesios 6:10-17 para llenar los espacios.

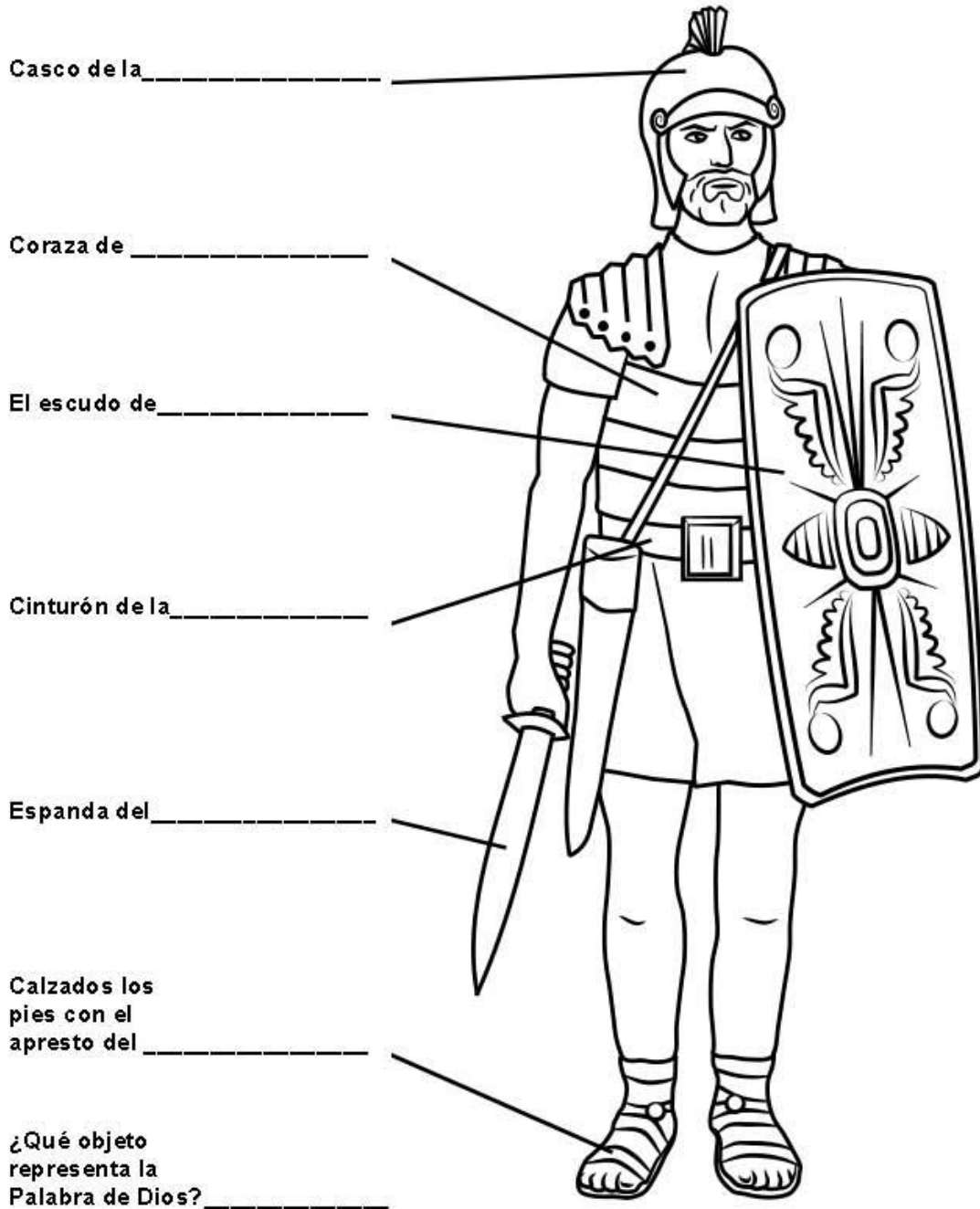



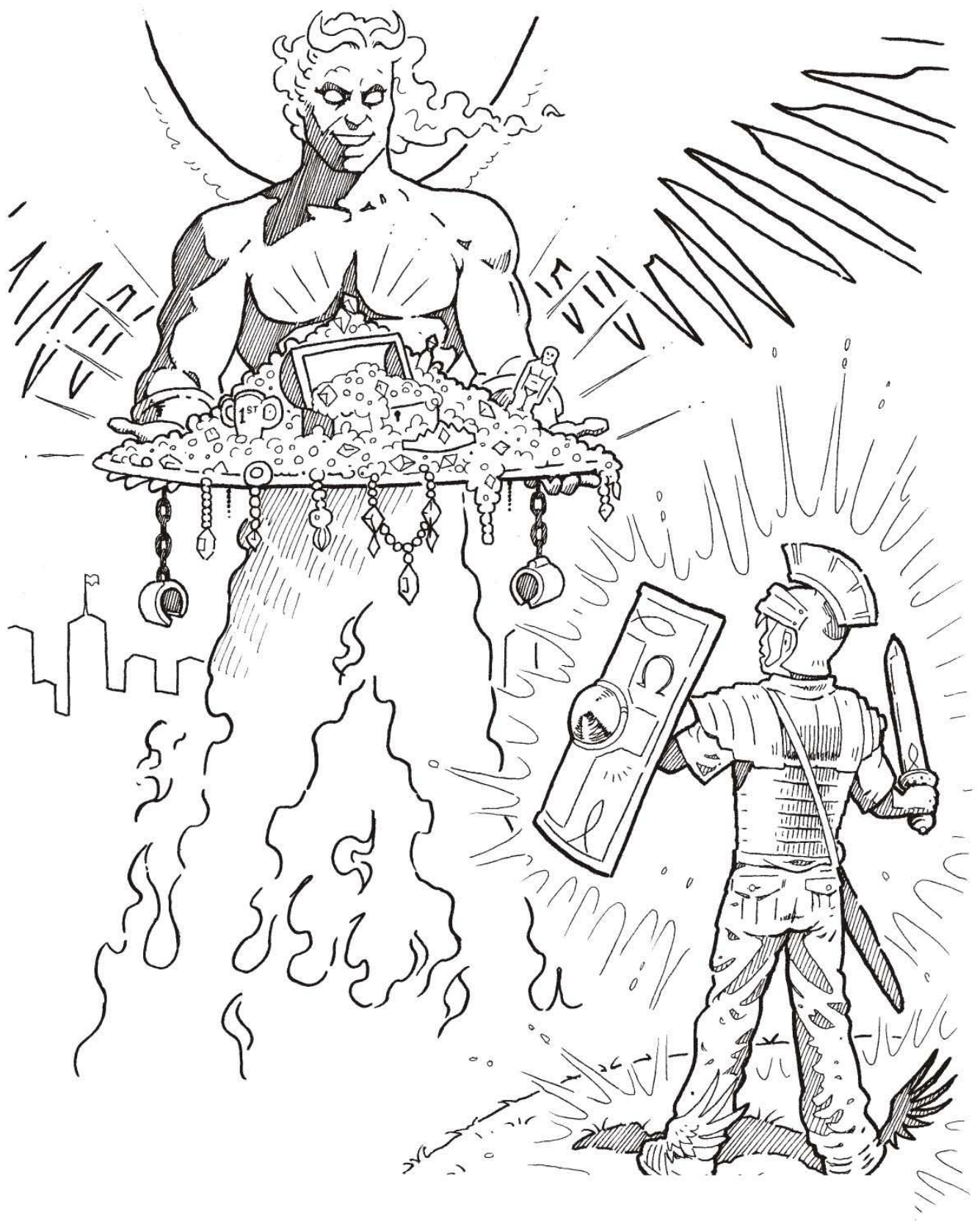



1 x

Armadura de Cristo

Ampliar 200%

Página 8

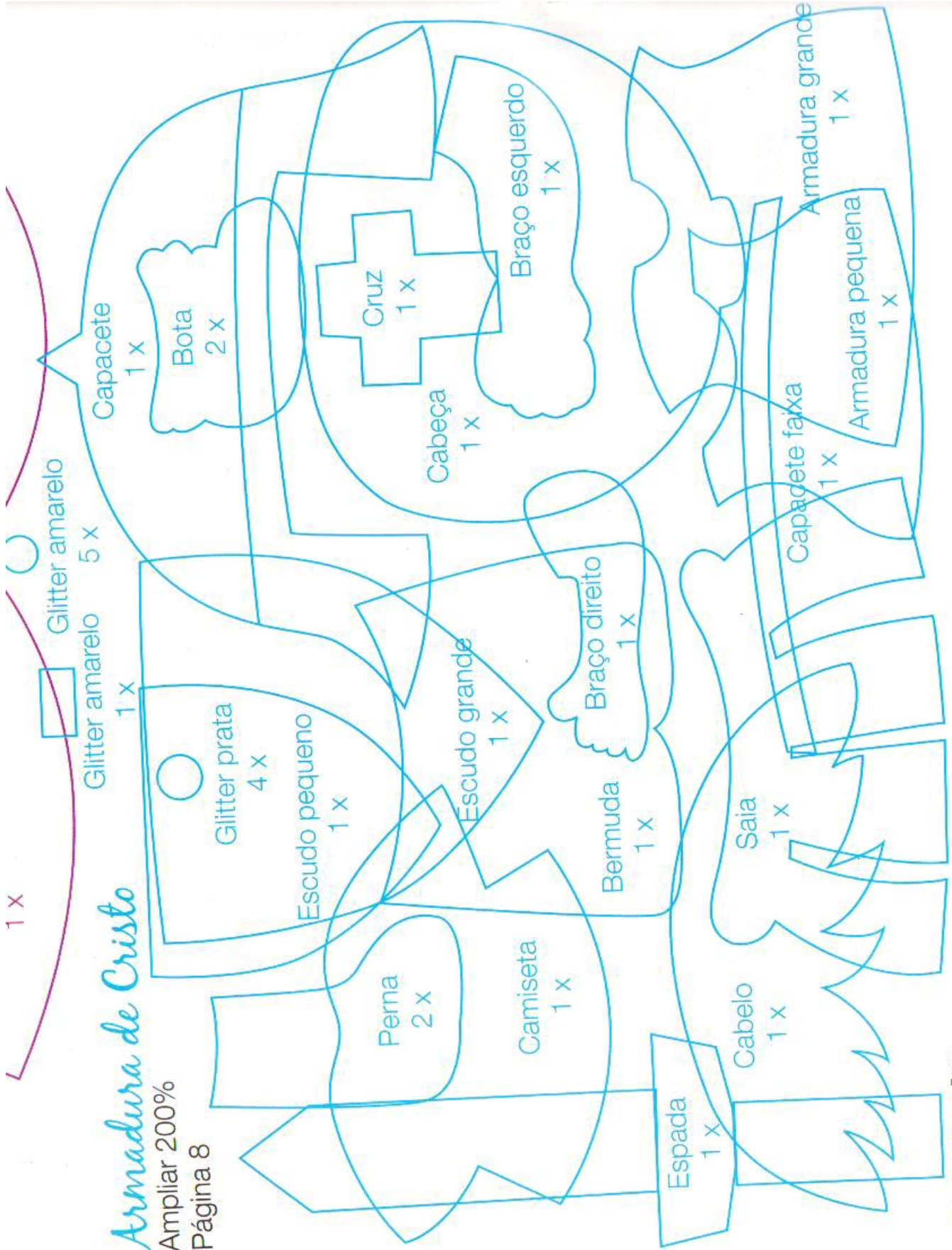

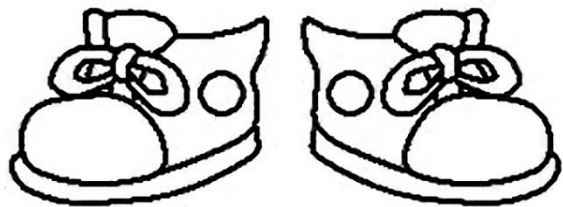
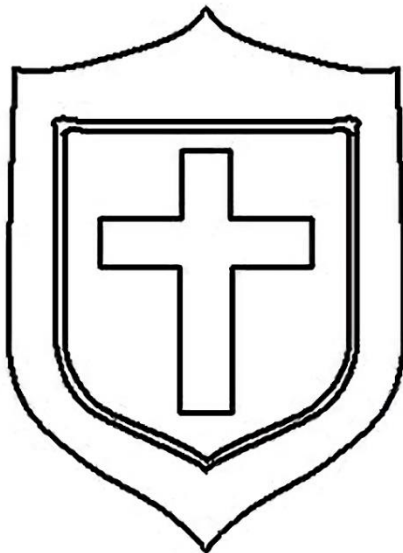
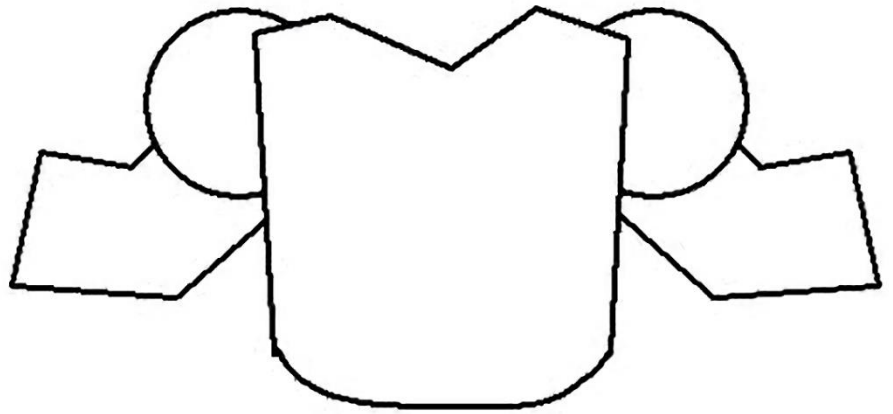
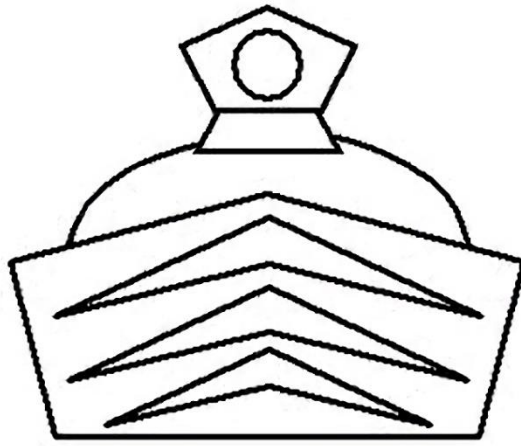
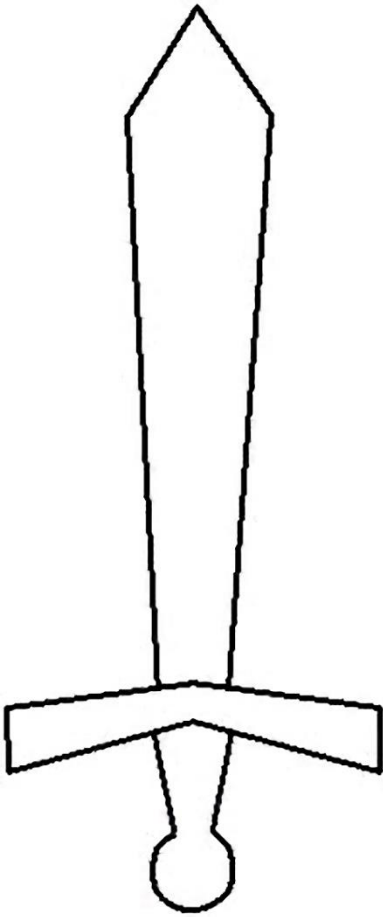

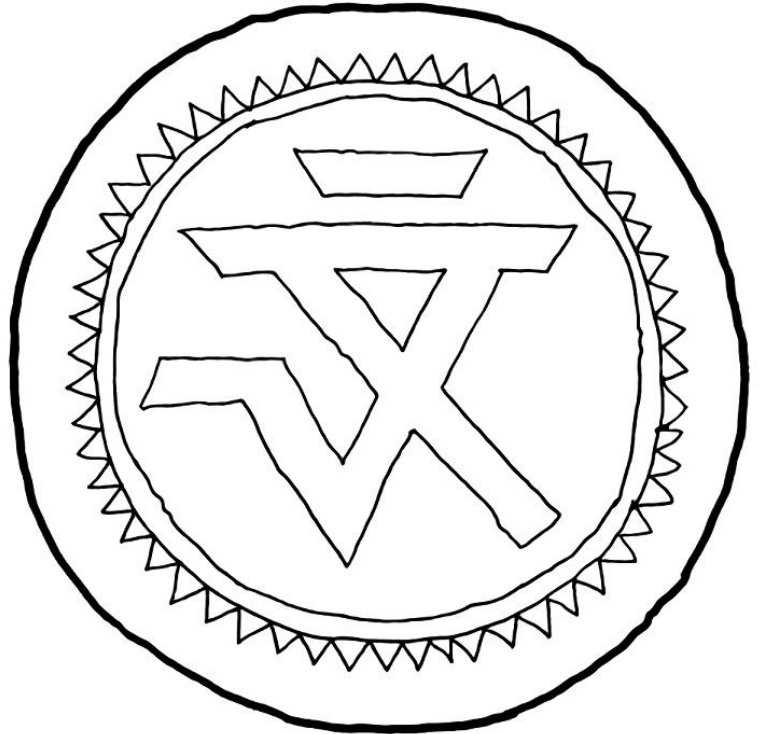
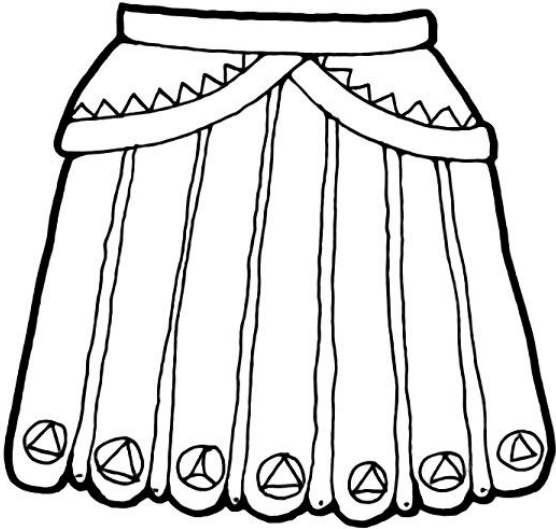
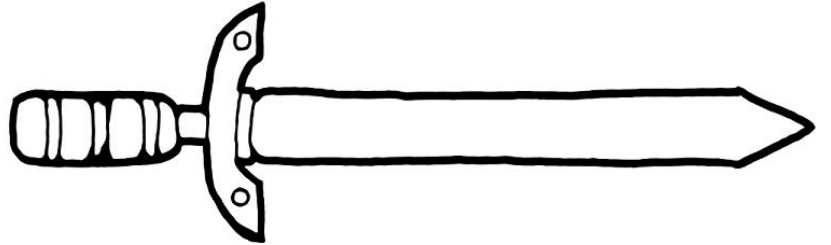
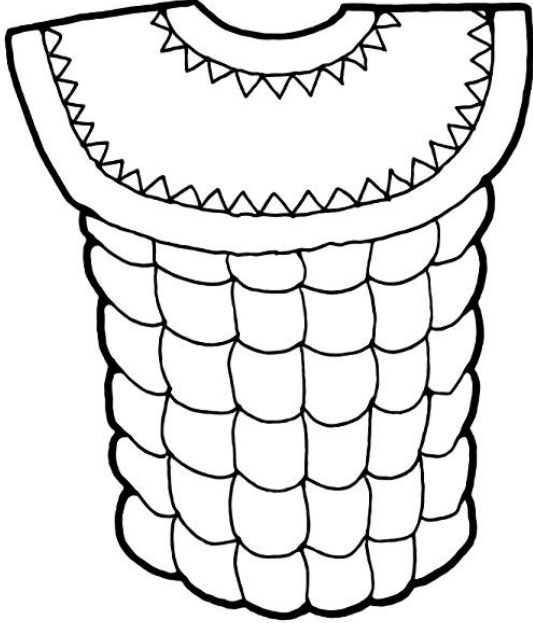
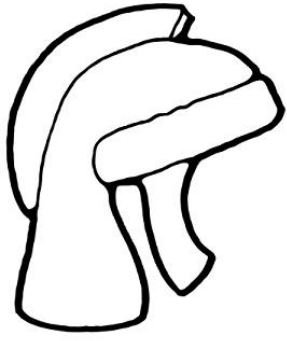

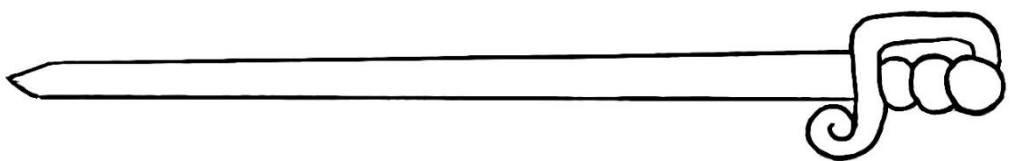
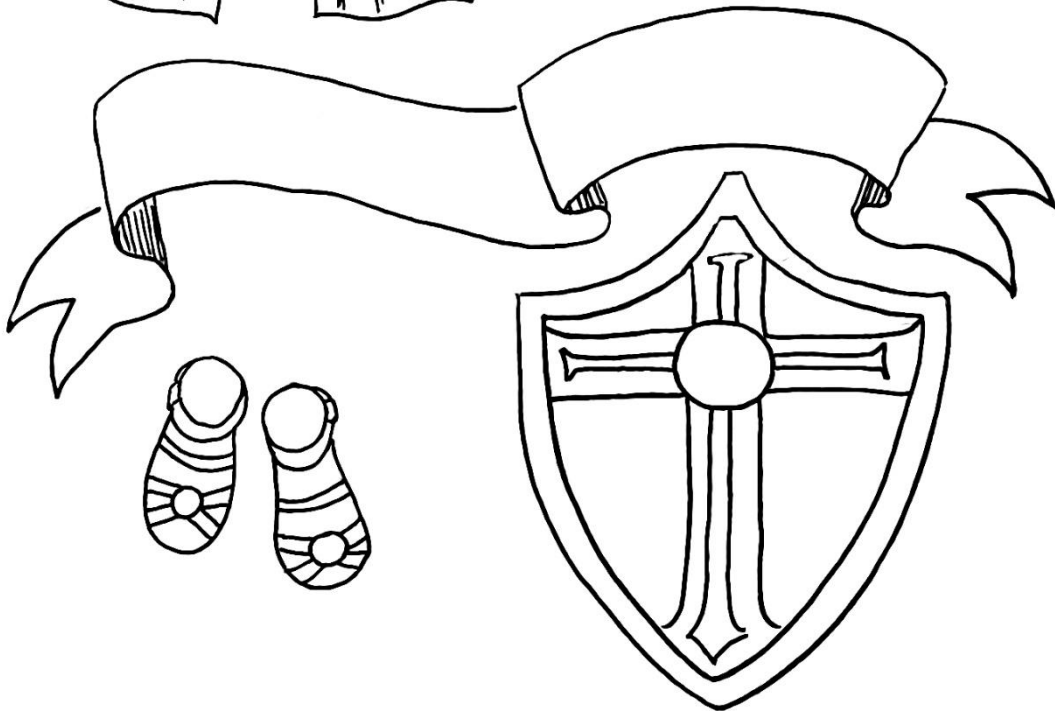
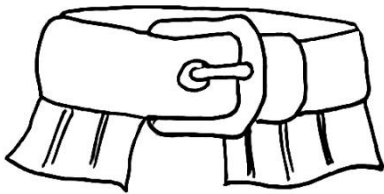
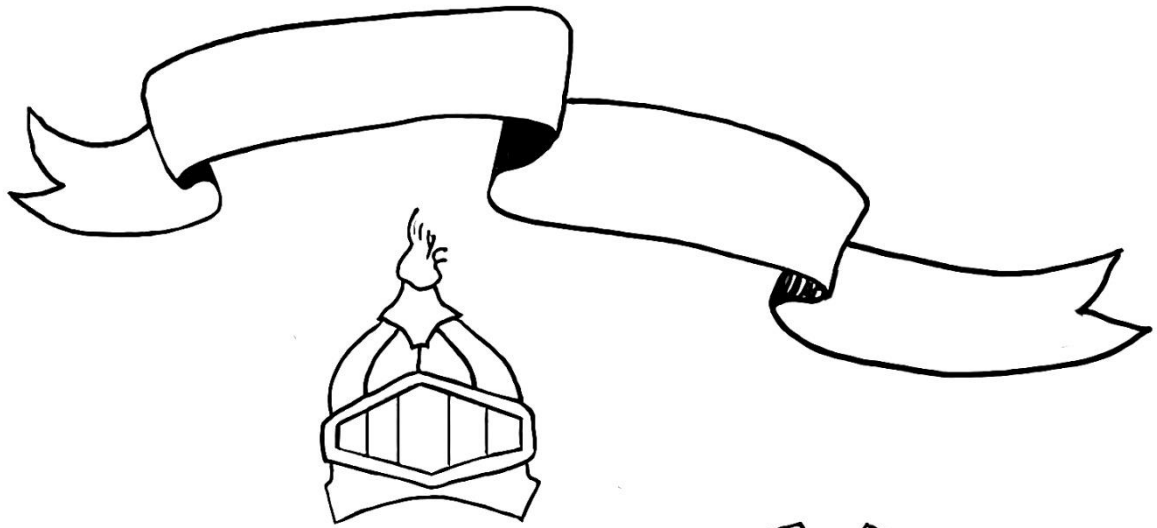

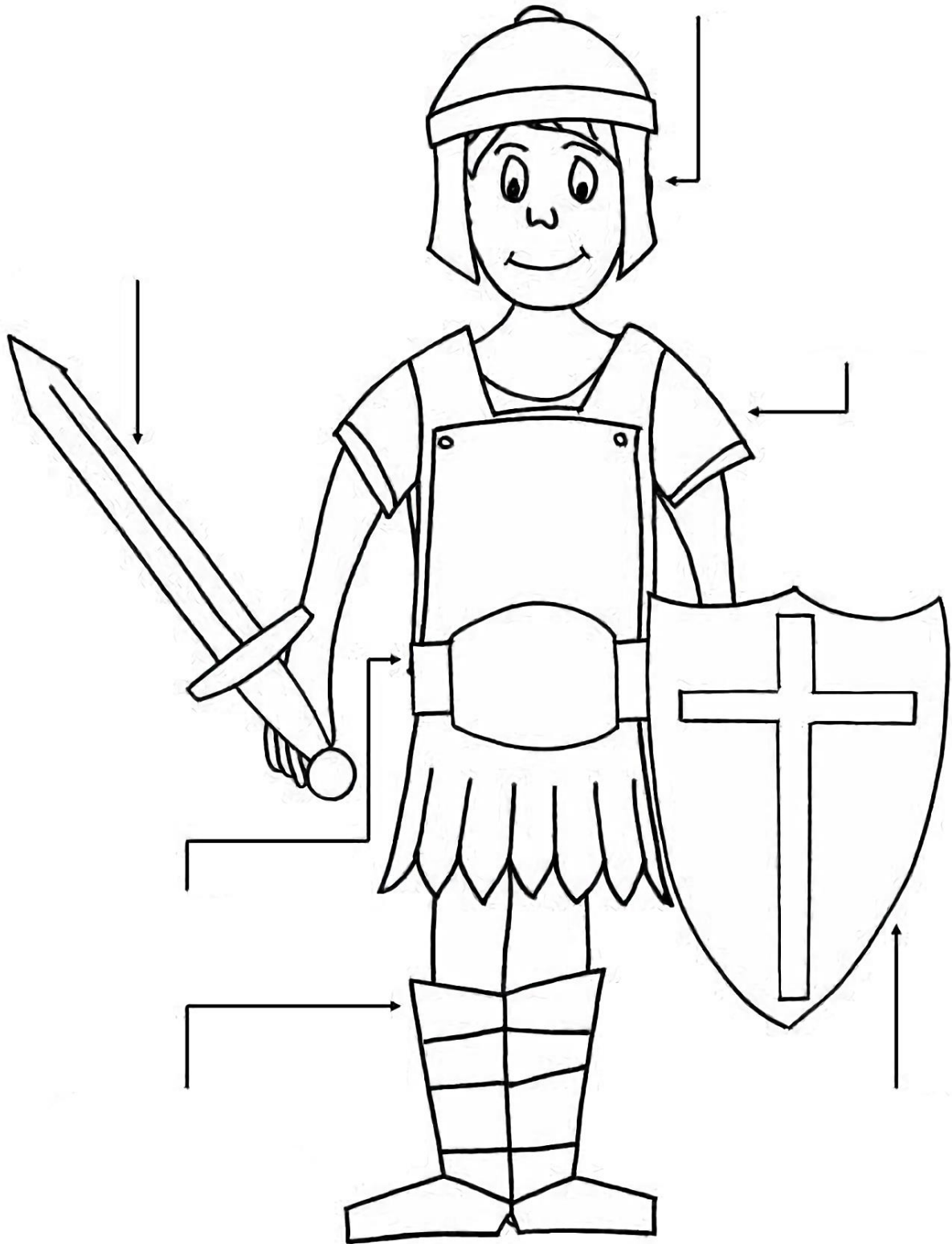

Ephesians 6:11-18

Put on the whole armor of God that you may be able to stand against the wiles of the devil.

... For we do not wrestle against flesh & blood, but against principalities, against powers, against the rulers of the darkness of this age, against spiritual hosts of wickedness in the heavenly places...

Therefore take up the whole armor of God... to withstand in the evil day...

& having done all, to stand.

... and take the helmet of salvation...

stand therefore having girded your waist with truth, having put on the breastplate of righteousness...

... above all taking the shield of faith with which you will be able to quench all the fiery darts of the wicked one.

... and the sword of the Spirit which is the word of God...

praying always with all prayer & supplication in the Spirit...

being watchful to this end with all perseverance & supplication for all the Saints...

... and having shod your feet with the preparation of the gospel of peace...

with blessings, Nadene @<http://practicalpages.wordpress.com>
April 2012



Ephesians 6:10

Put on the whole armor of God, that you may be able to stand against the wiles of the devil.

That you may be able to withstand in the evil day, and having done all, to stand.

... and take the helmet of salvation ...

... having put on the breastplate of righteousness ...

... stand having girded your waist with truth ...

... being watchful to this end with all perseverance and supplication for all the saints ...

... praying always with all prayer and supplication in the Spirit ...

... and the sword of the Spirit, which is the word of God ...

... Above all, taking the shield of faith with which you will be able to quench all the fiery darts of the evil one ...

... having shod your feet with the preparation of

the gospel of peace

For we do not wrestle against flesh and blood but against principalities, against powers, against the rulers of the darkness of this age, against spiritual hosts of wickedness in the heavenly places.

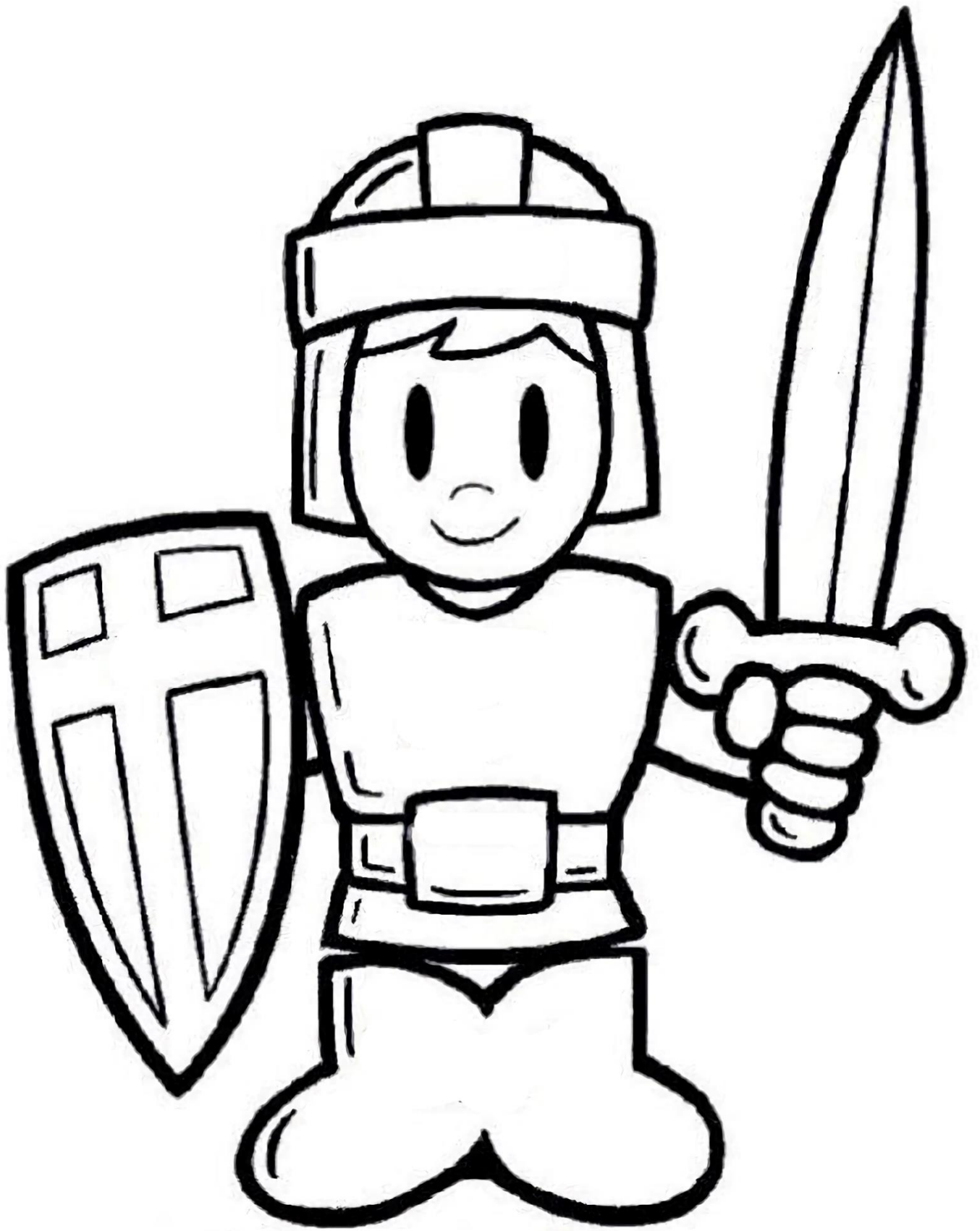

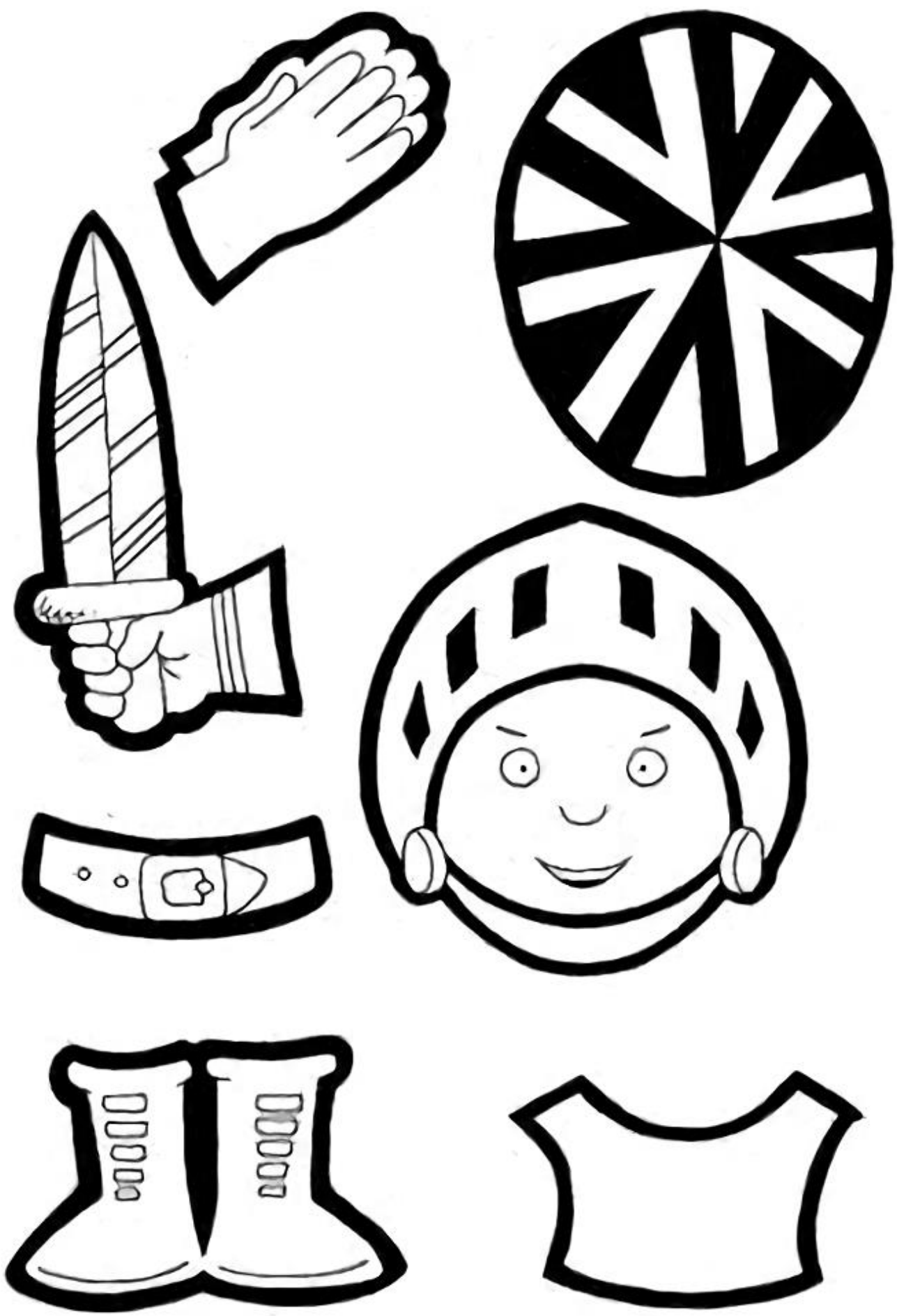

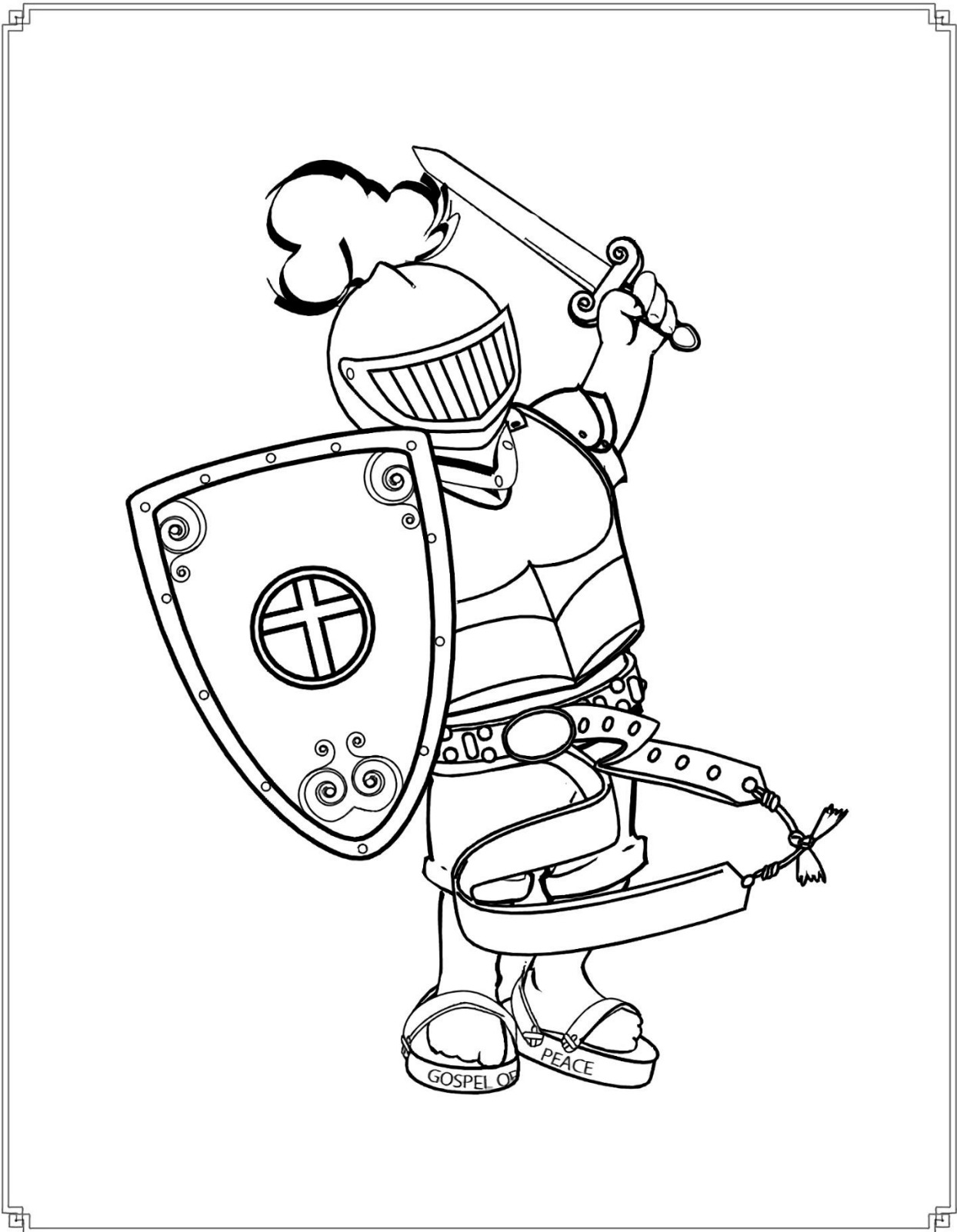









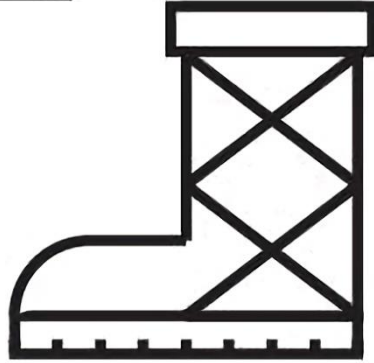
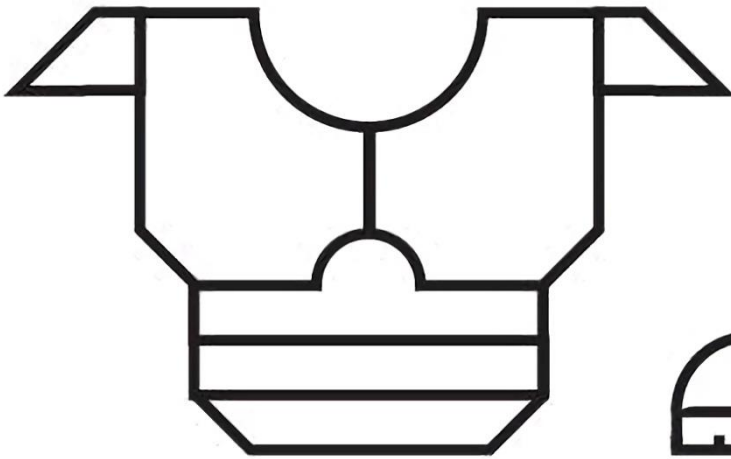
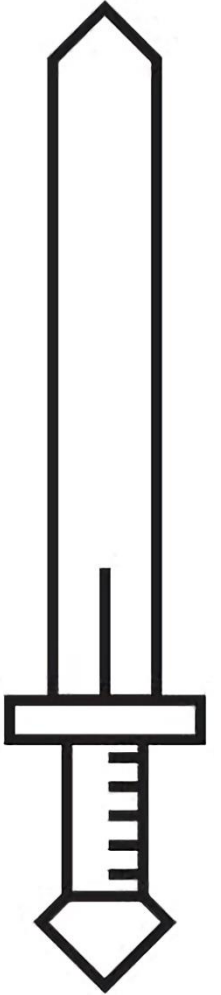
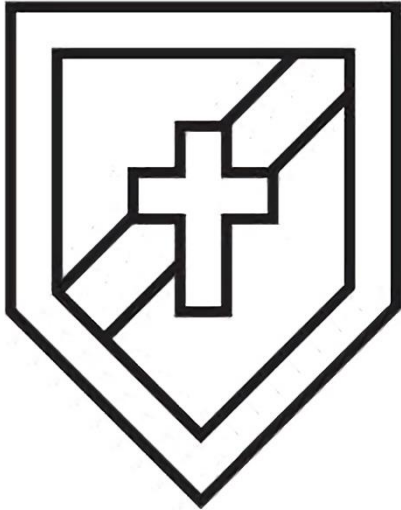

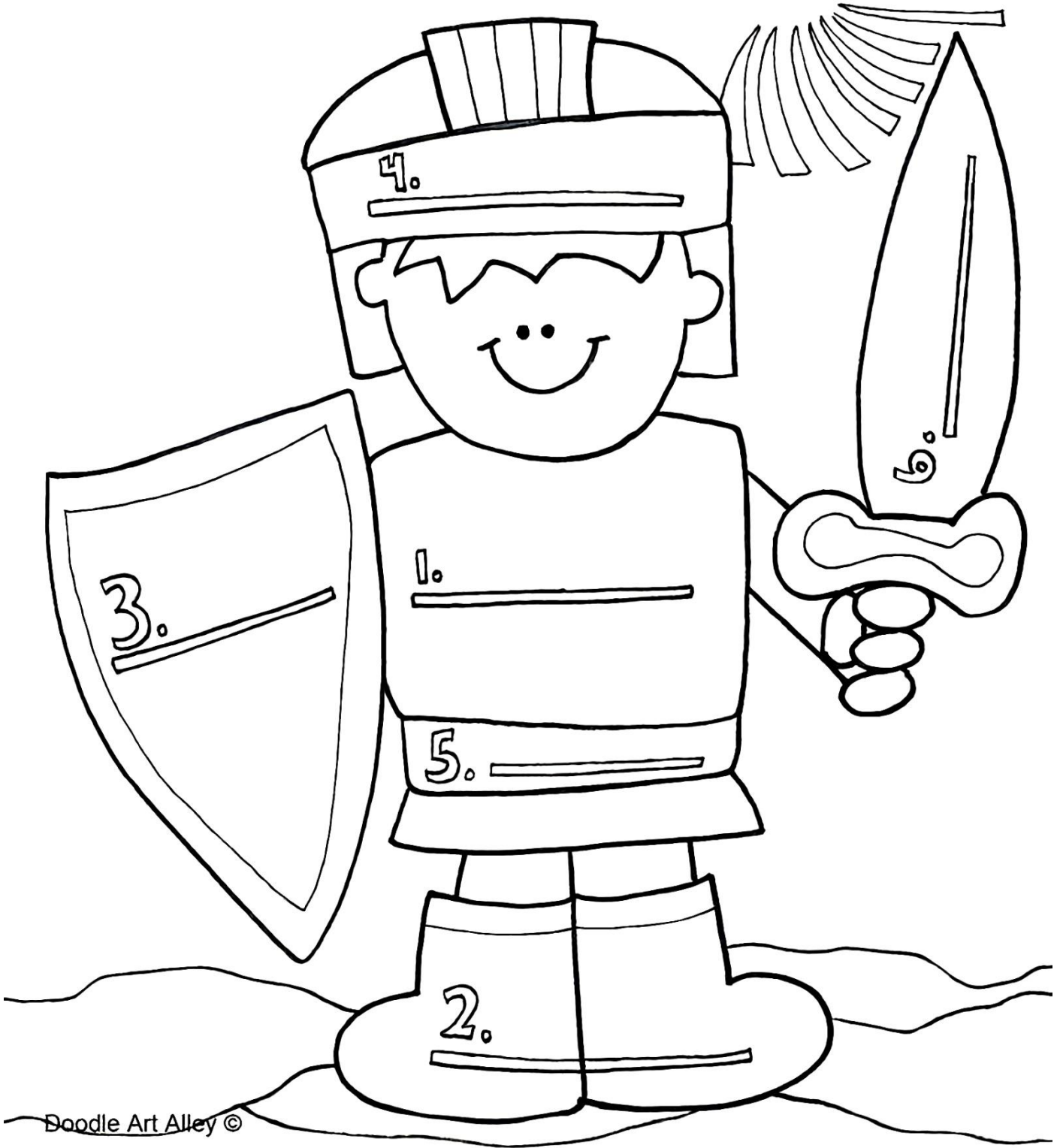

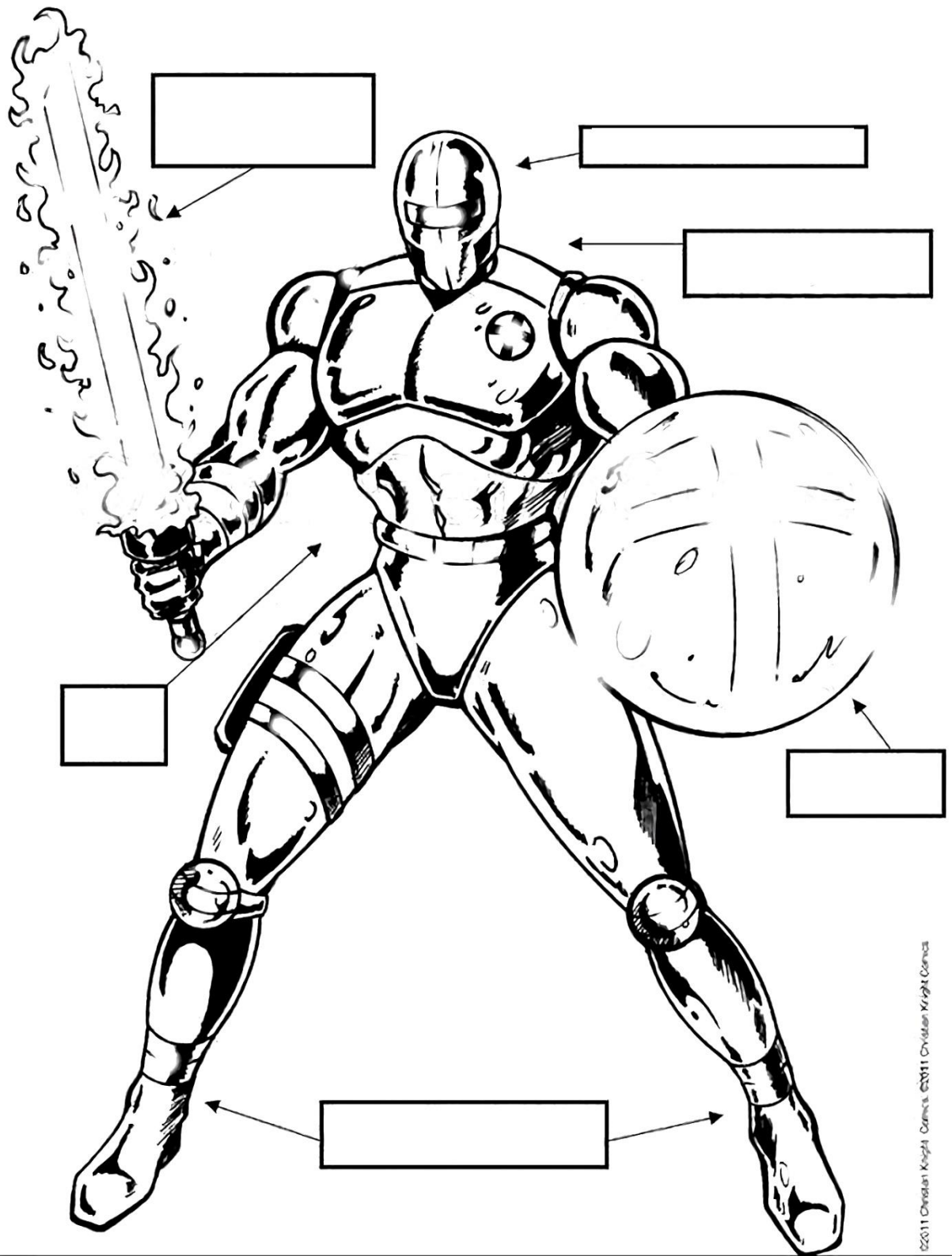

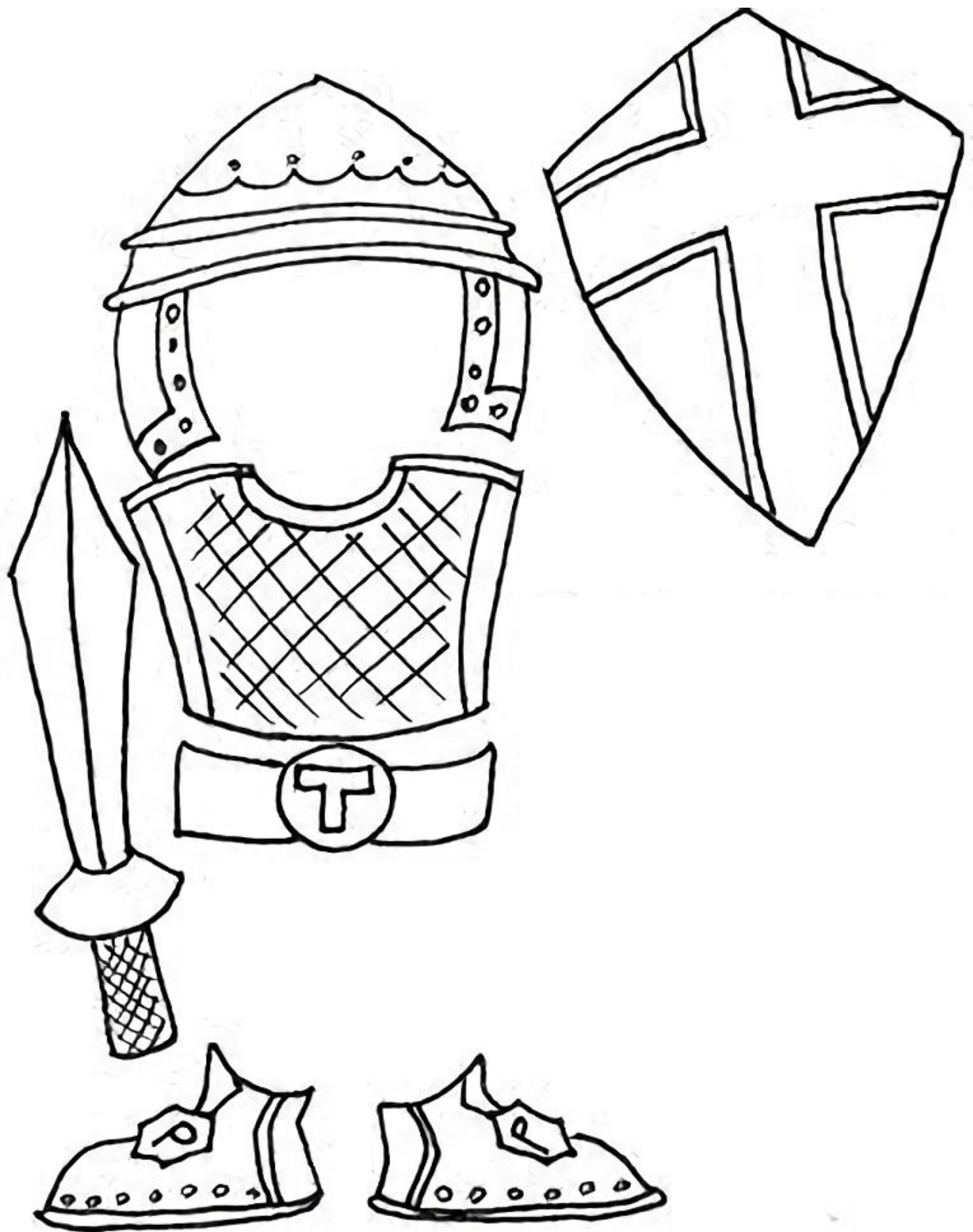



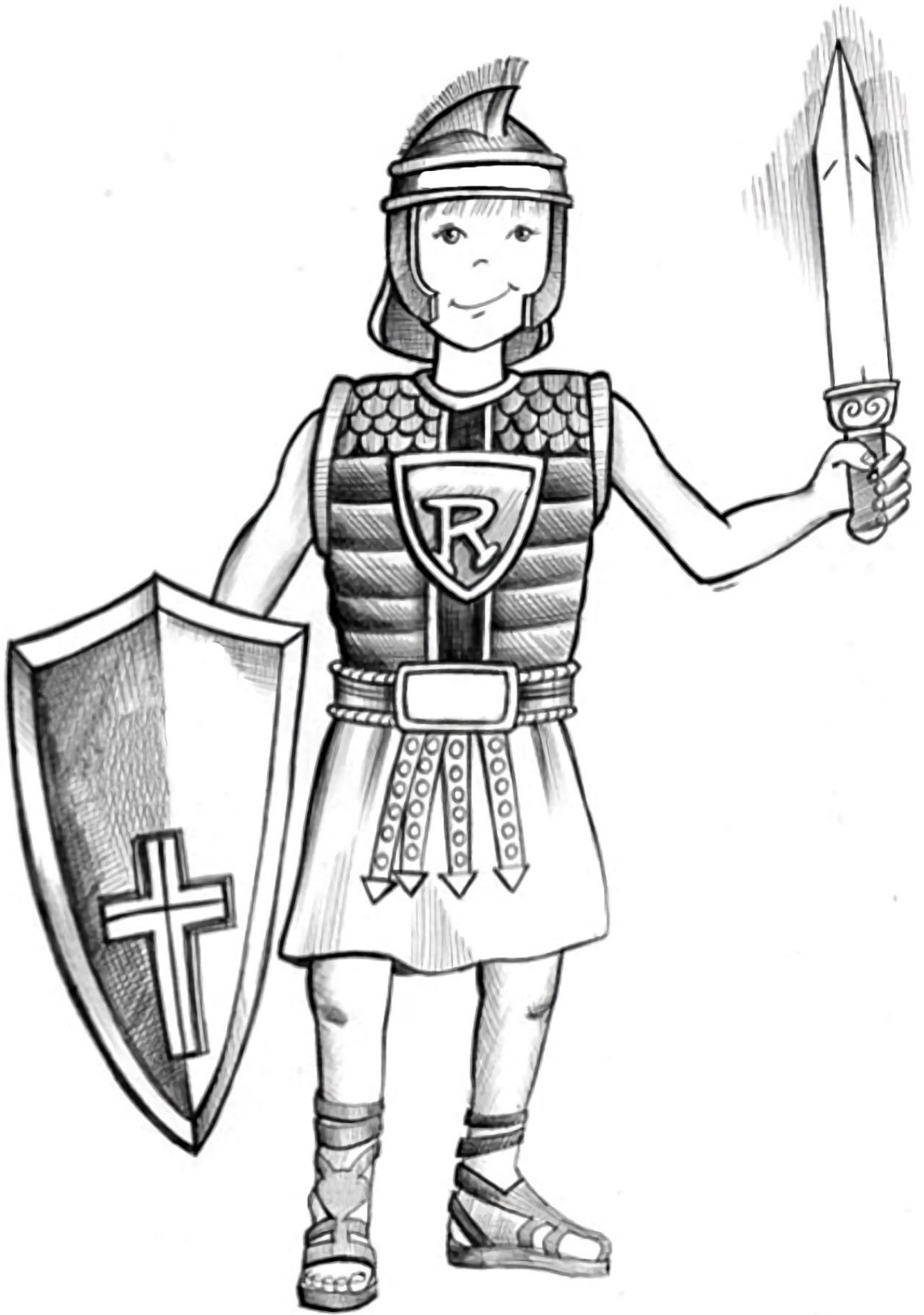

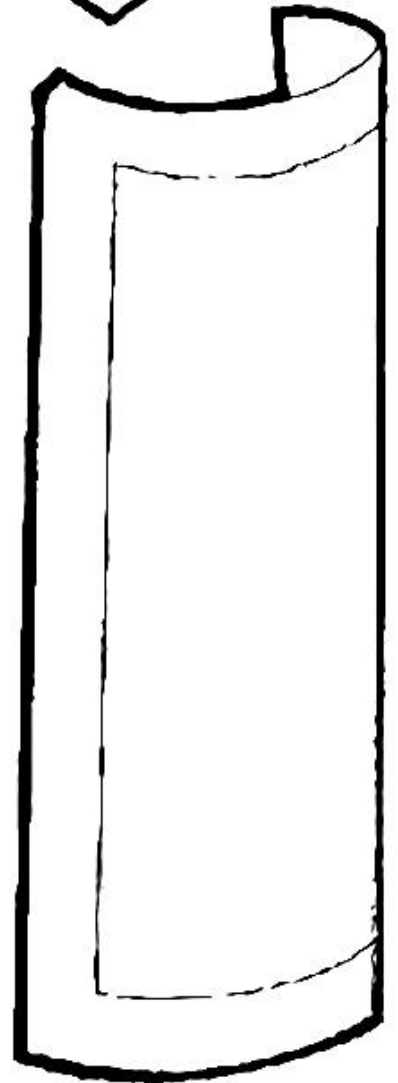
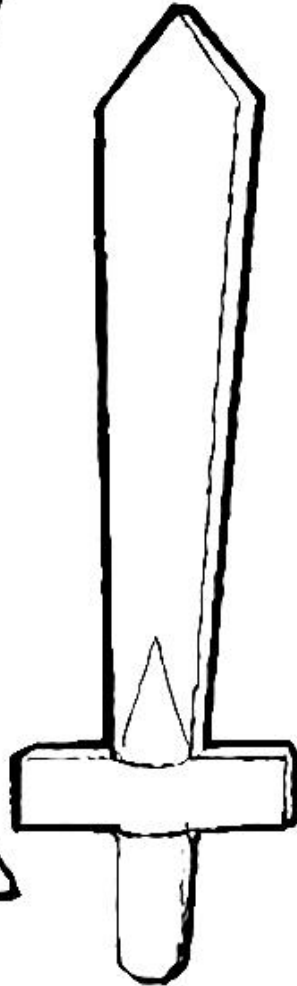
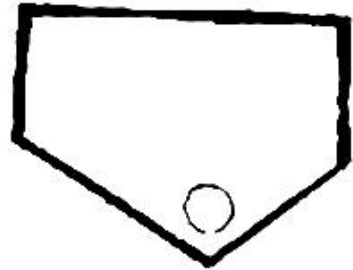
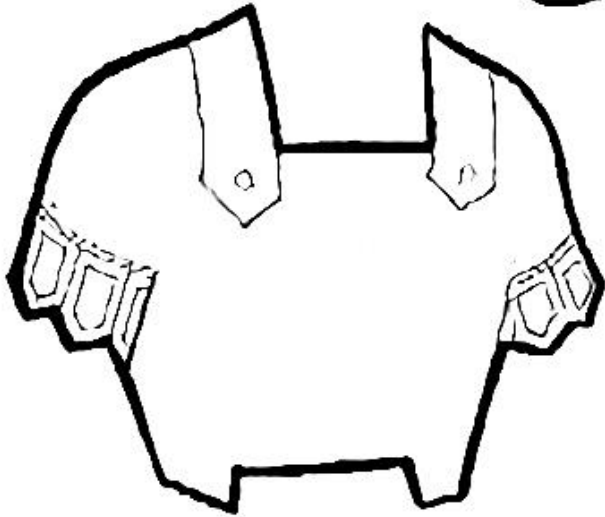
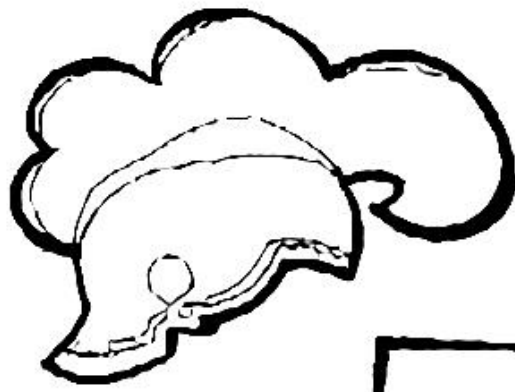

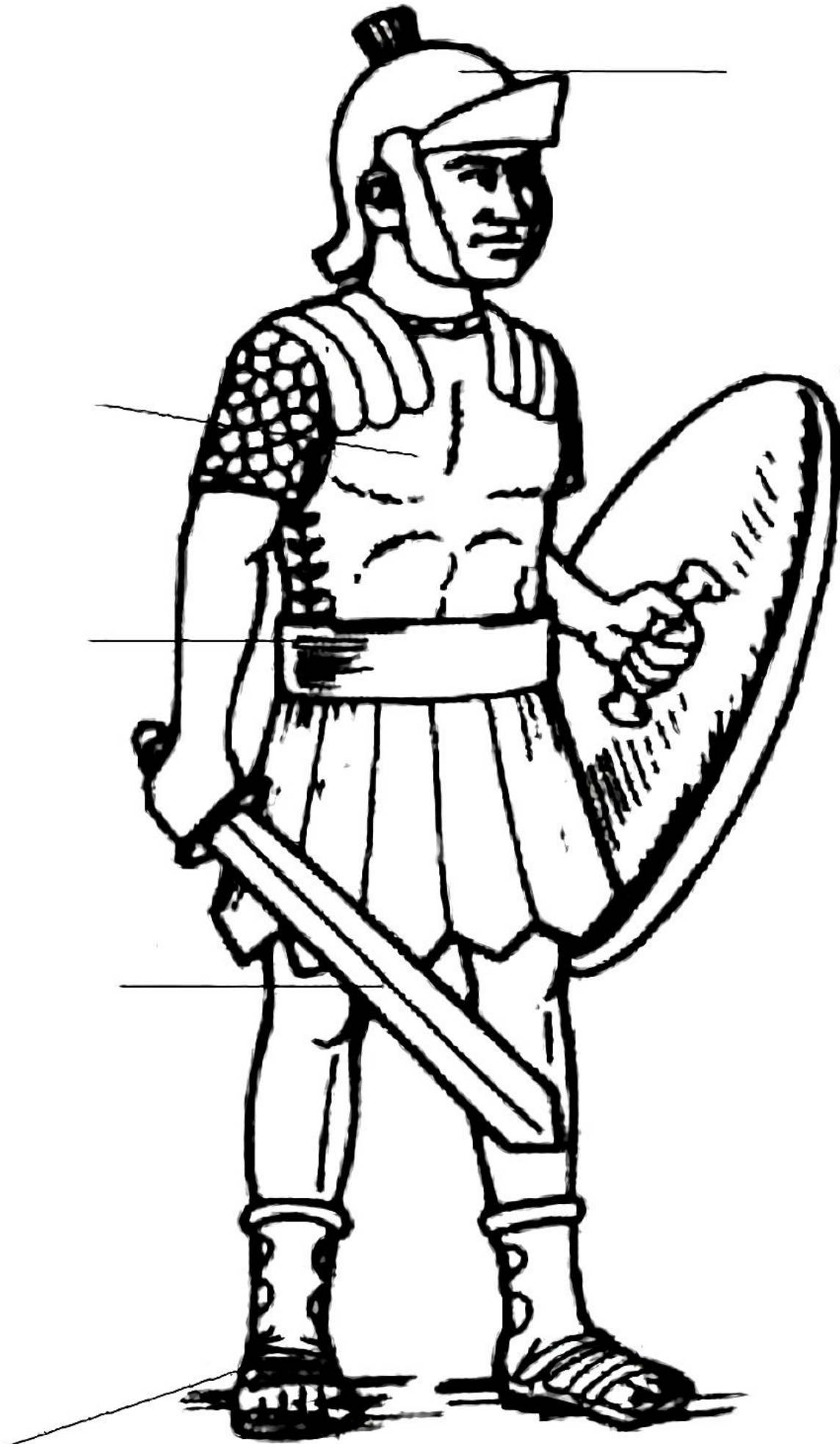

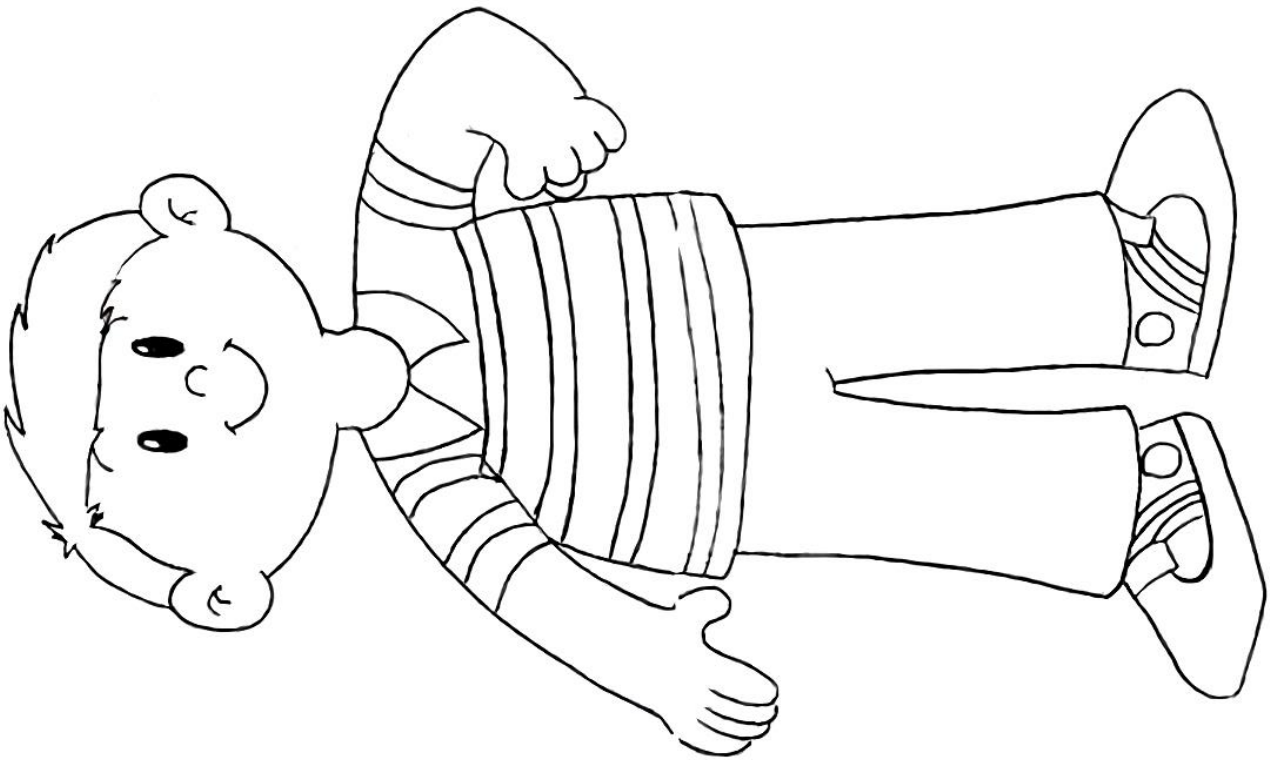
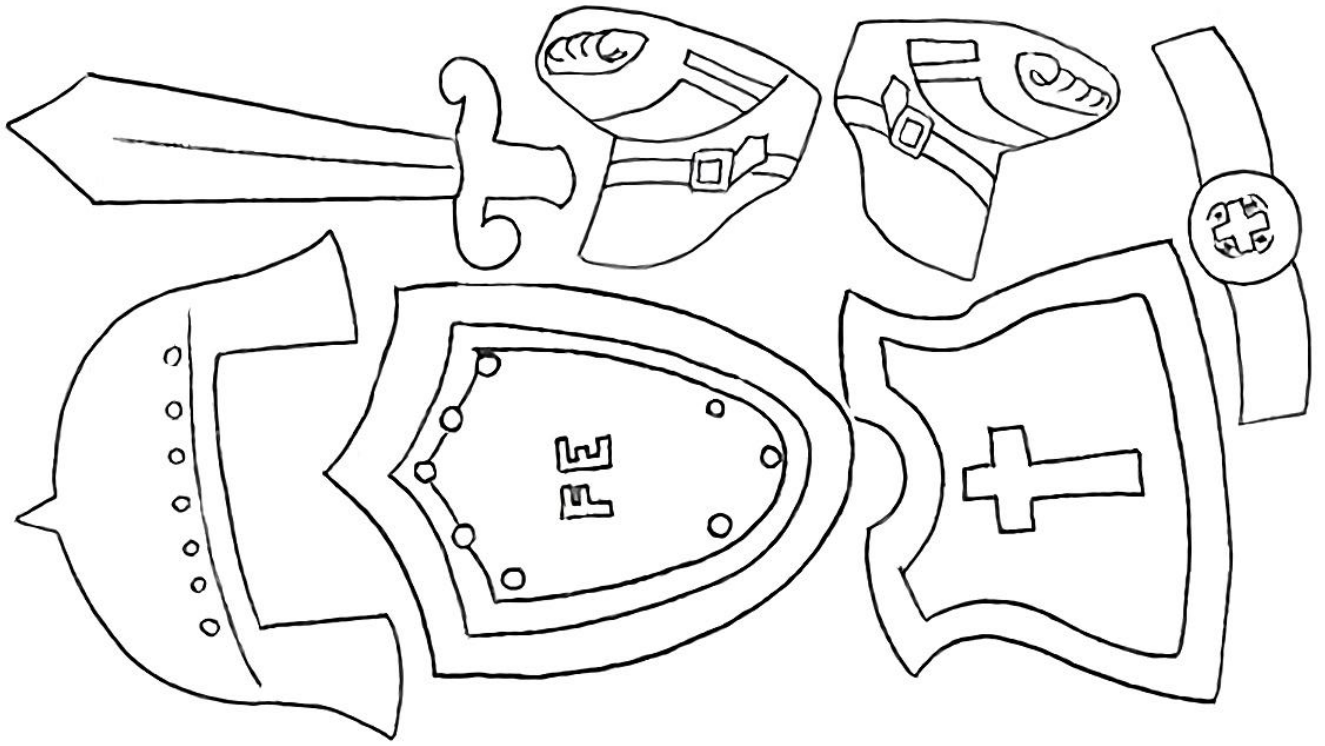

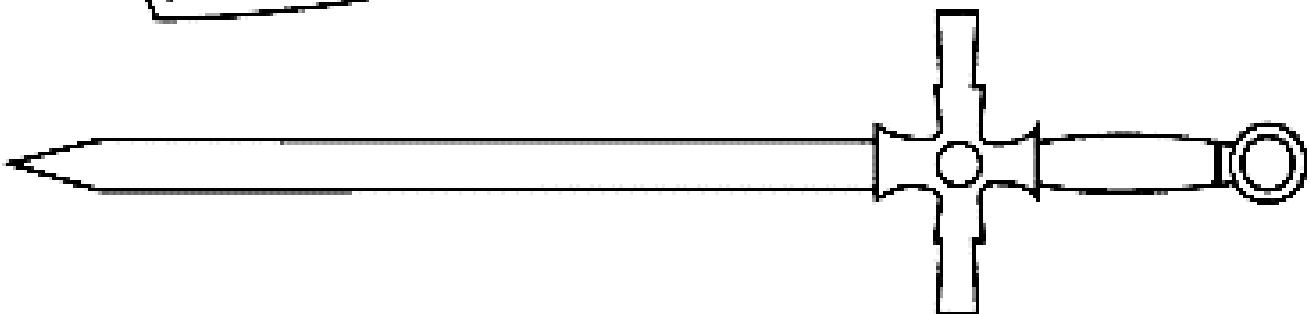
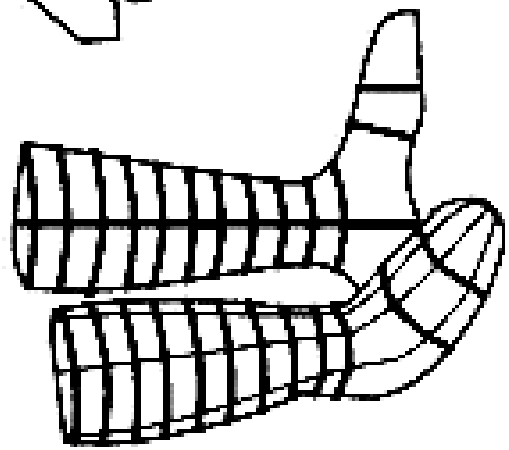
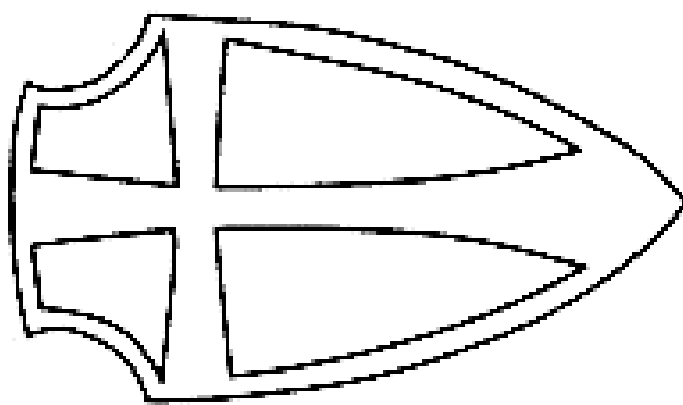
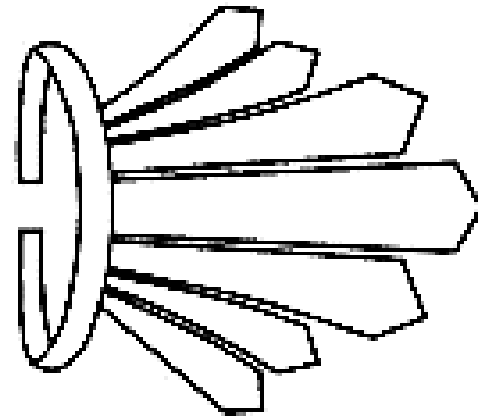
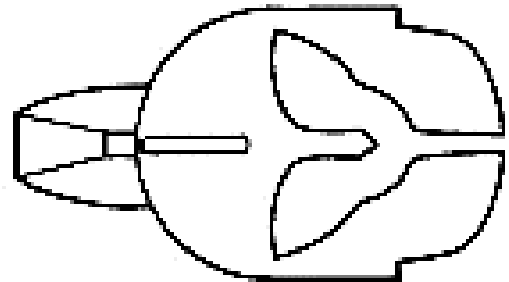
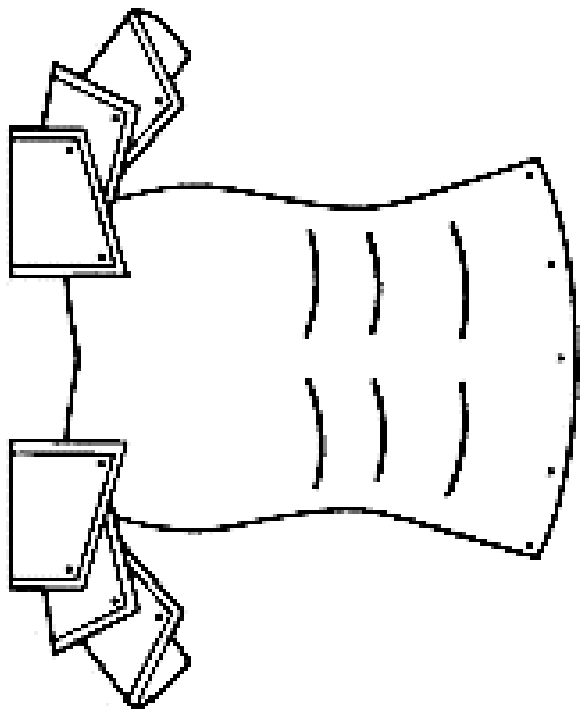

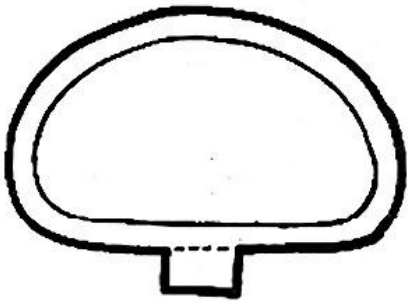
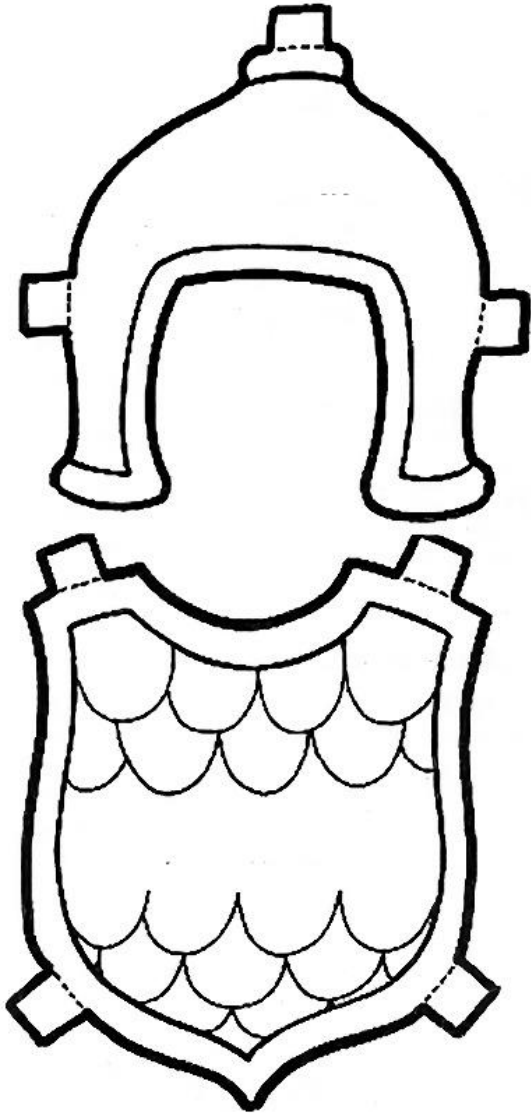
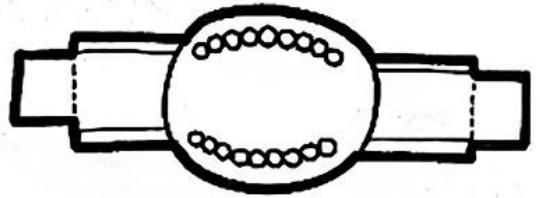
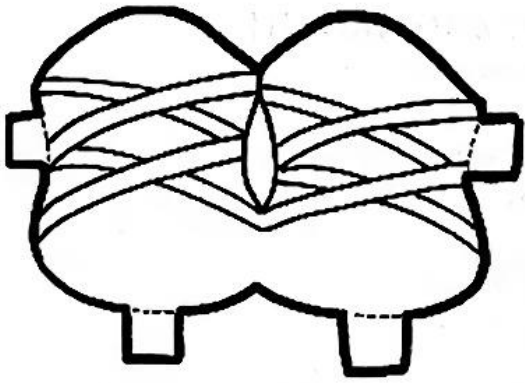

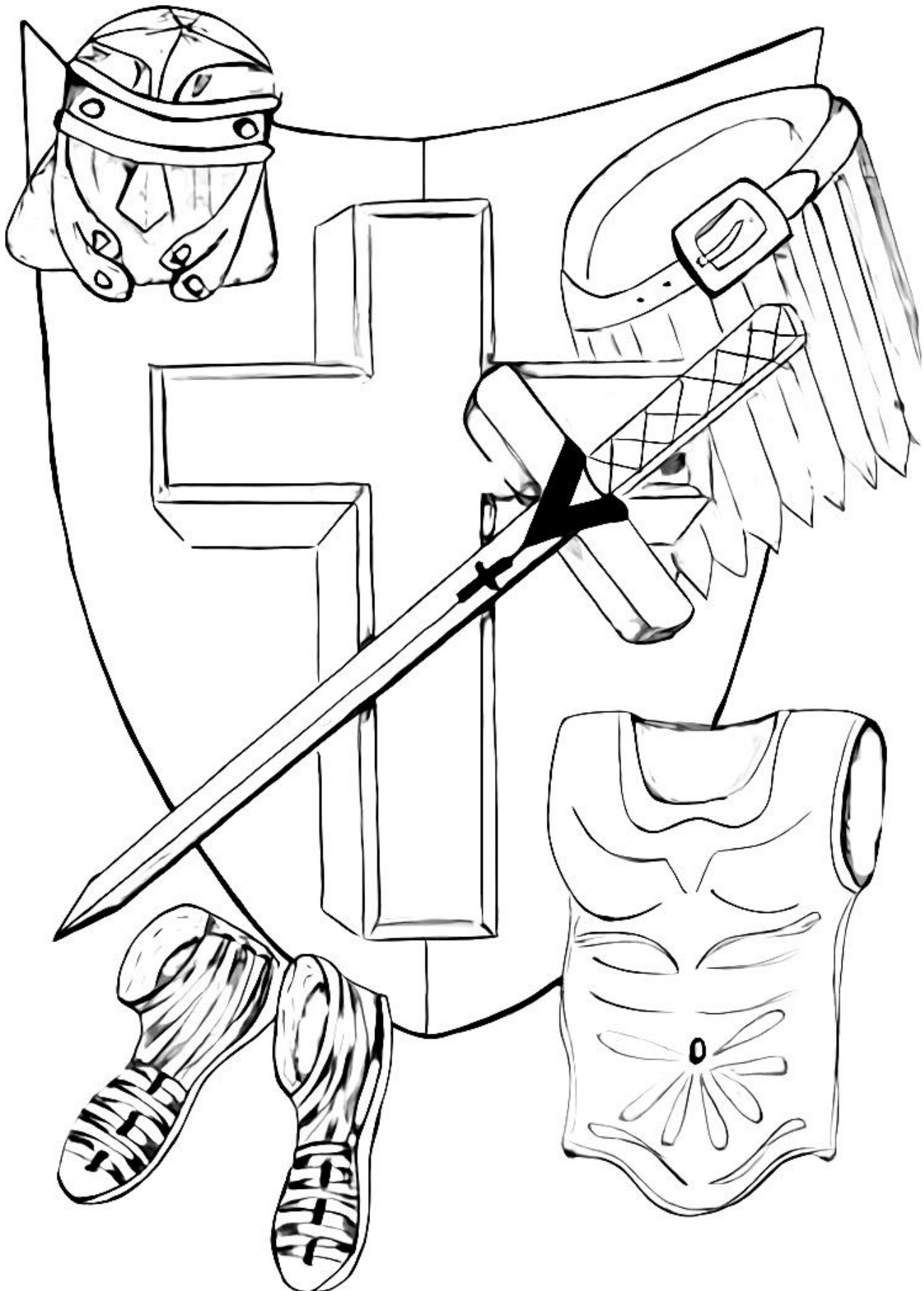

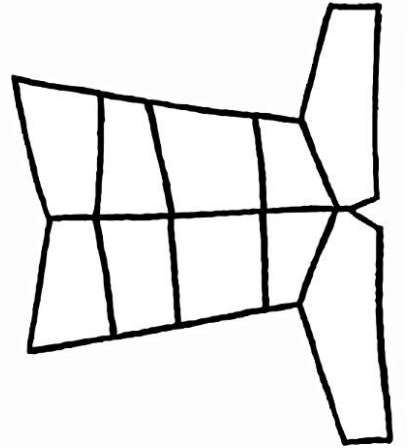
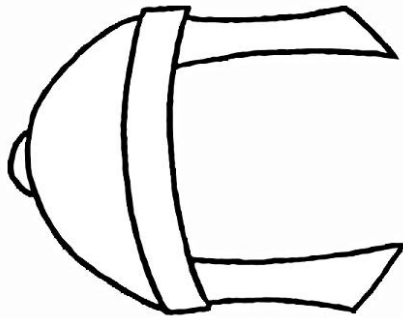
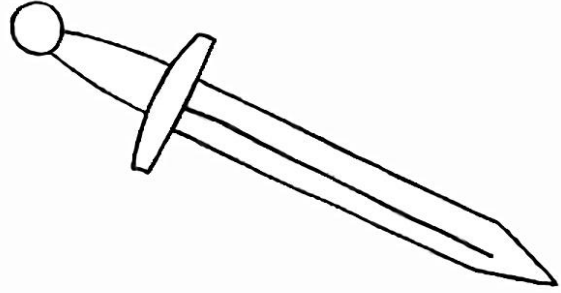
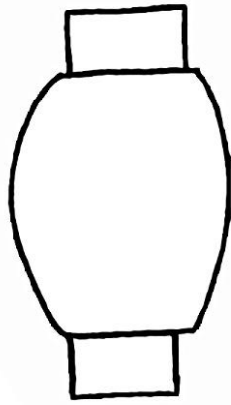
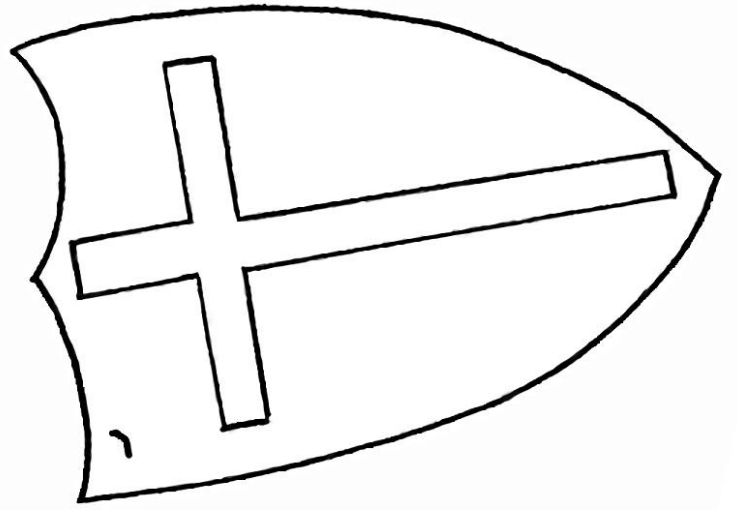
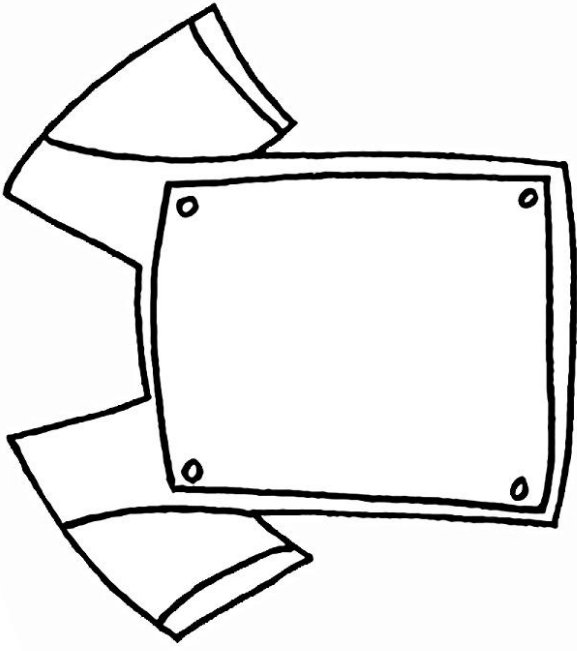

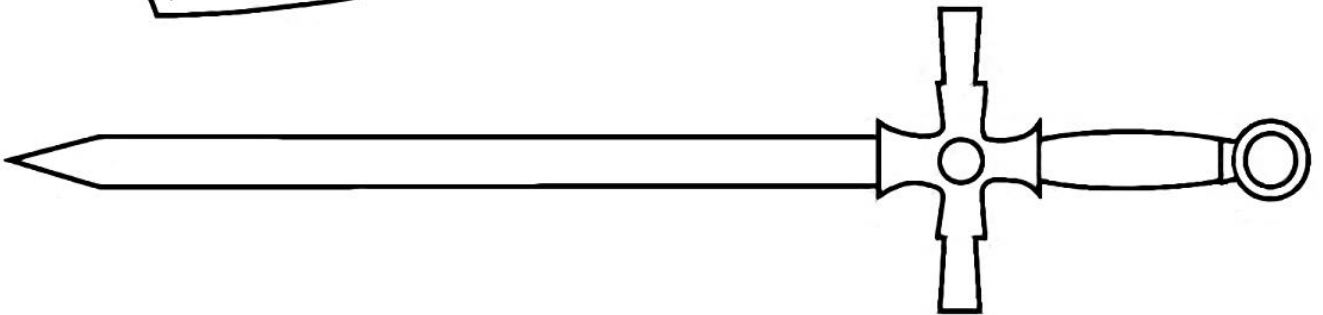
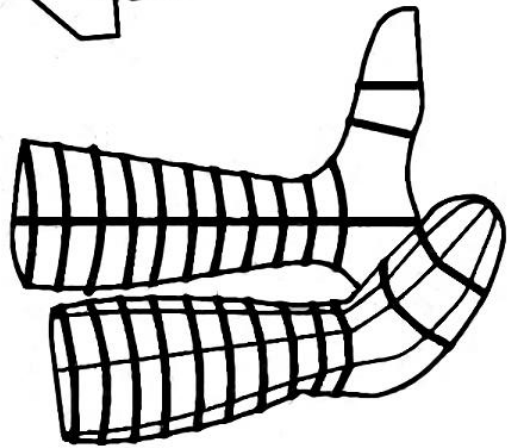
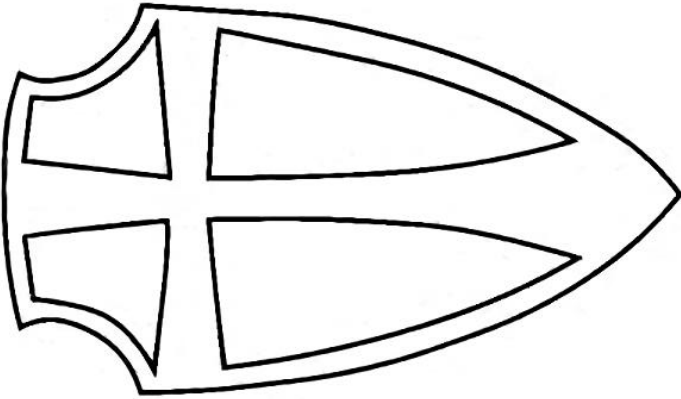
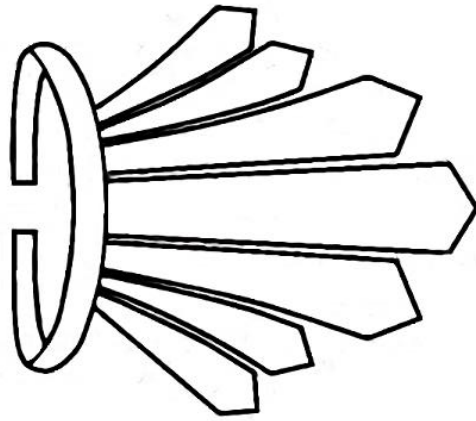
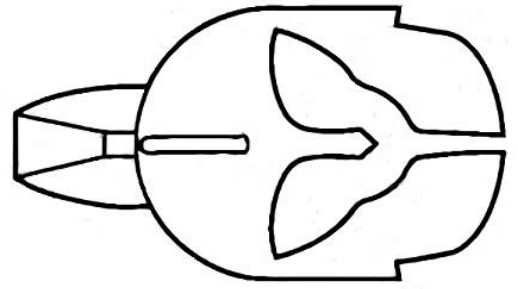
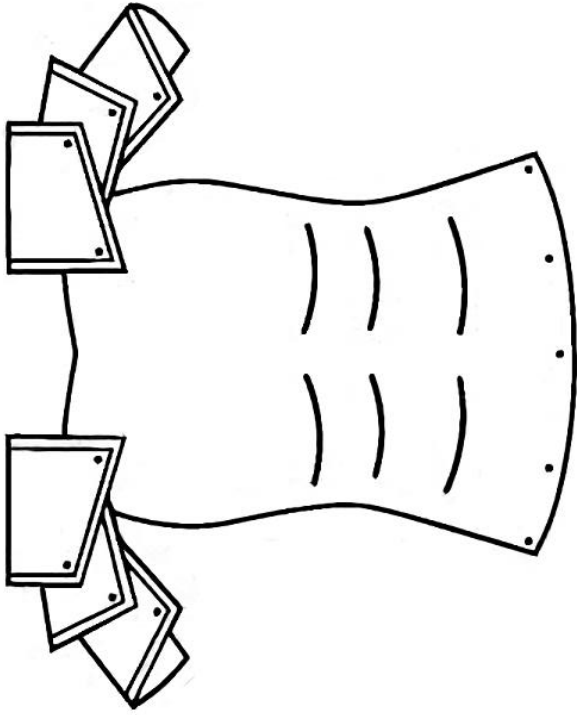

ВОИН ХРИСТА

Ефесеям 6:10-12

“Облекитесь во всеоружие Божие, чтобы вам можно было стать против козней диавольских...” (Ефесеям 6:11).

Помелка “Сборный солдат”



- копии образцов
- ножницы
- клей
- цветные карандаши
- скрепки
- картон (по желанию)
- дырокол



1. Сделайте копии образцов на тонком картоне или на обычной бумаге, приклейте их на картон.
2. Раскрасьте и вырежьте.
3. Сделайте отверстия в указанных точкой местах и соедините все части помелки скрепками.
4. На броне напишите золотой стих.

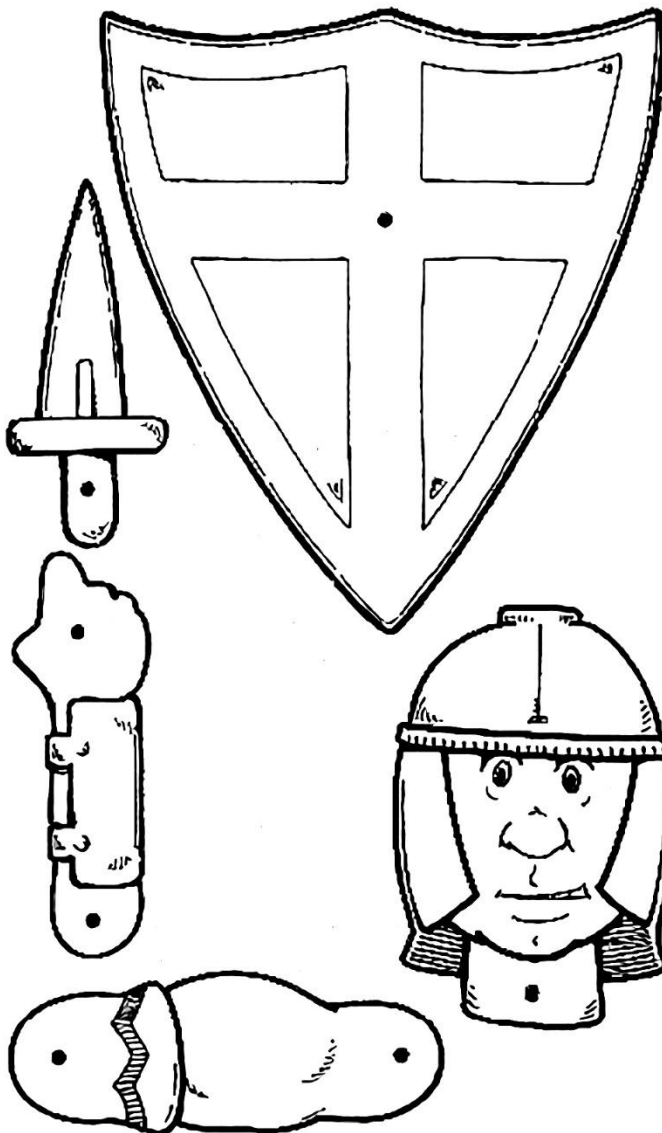
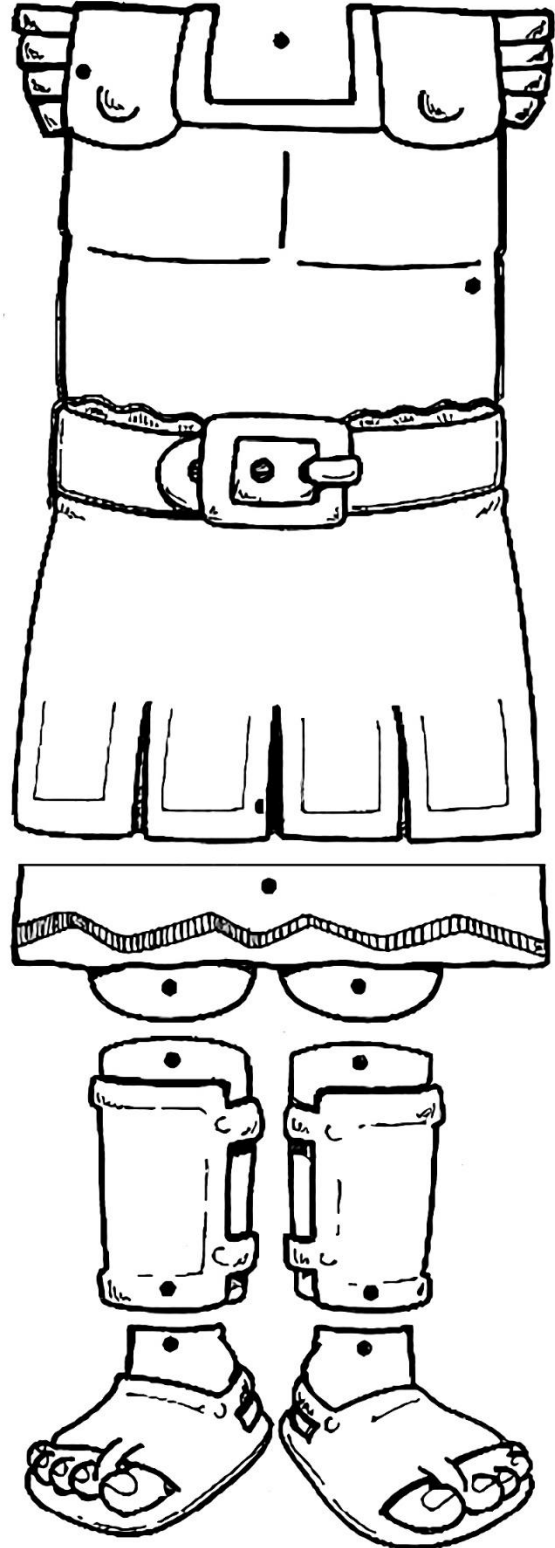

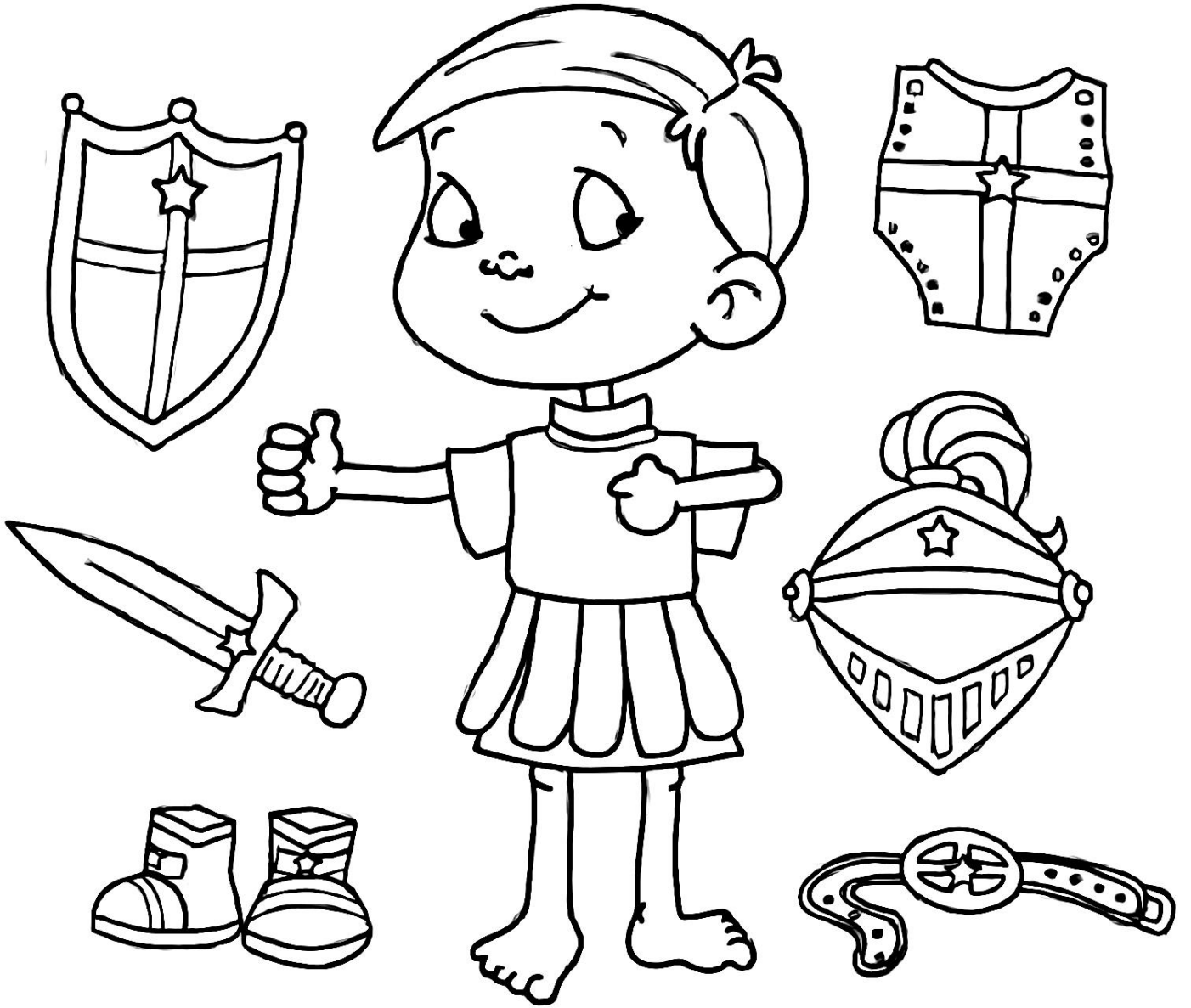

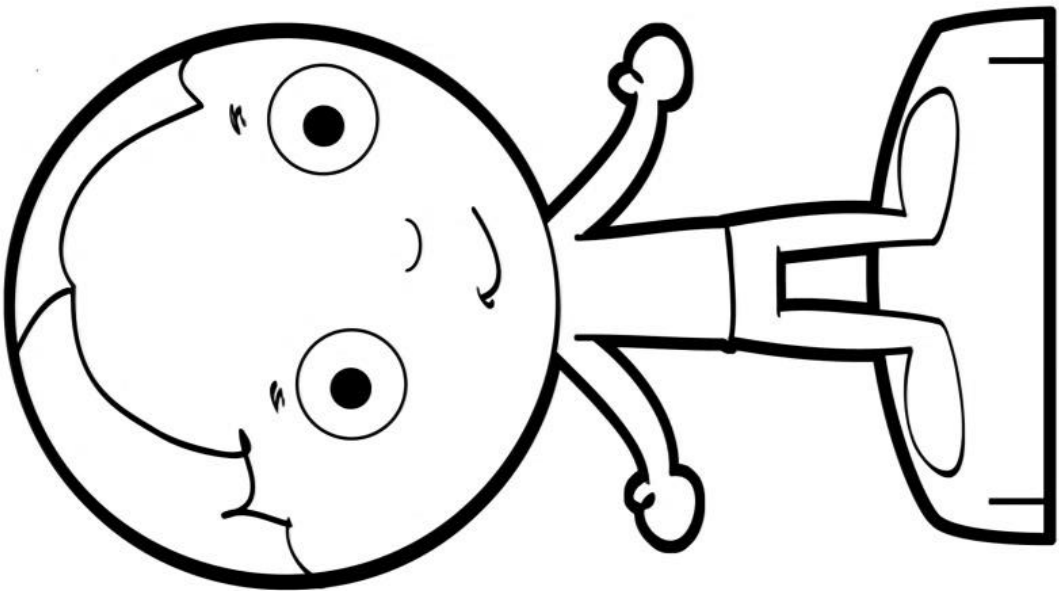
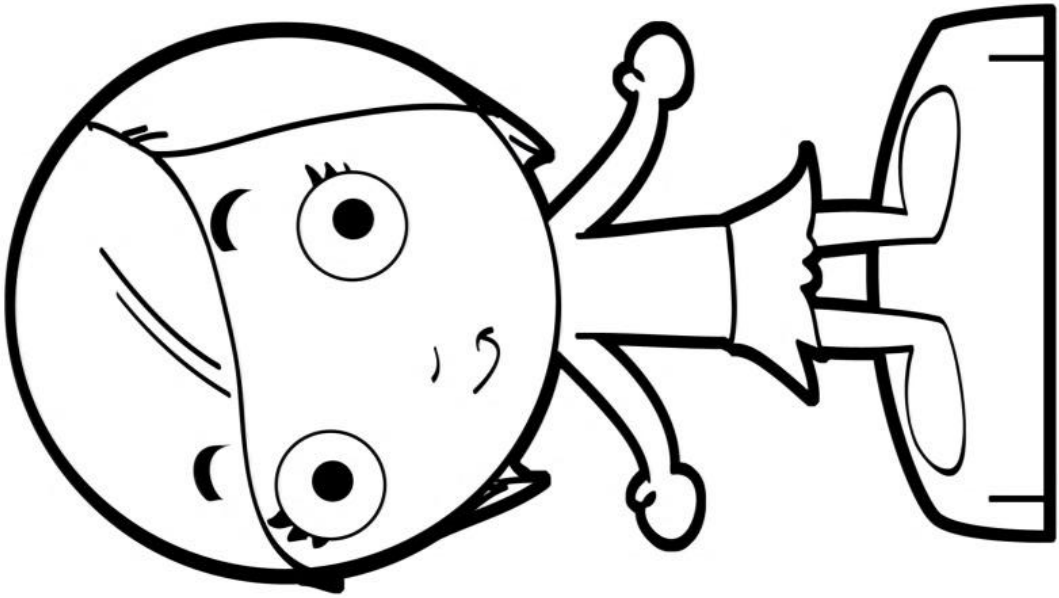

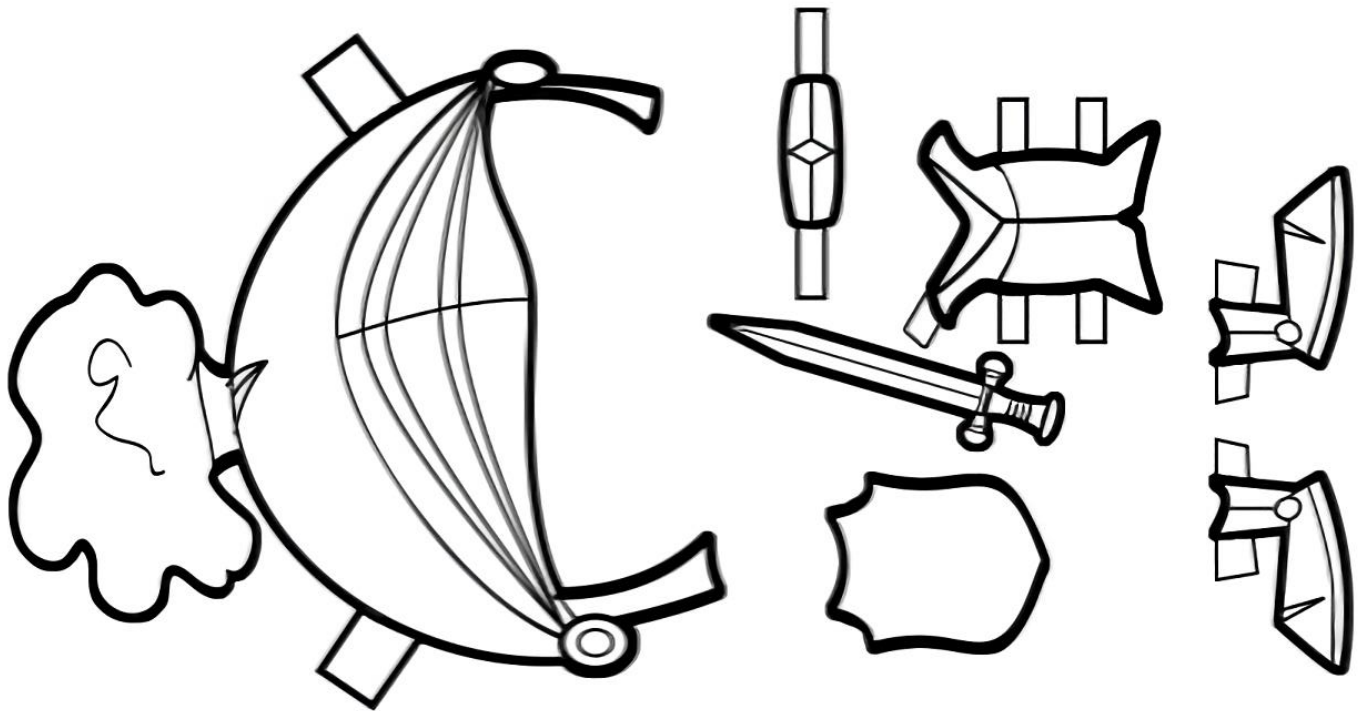
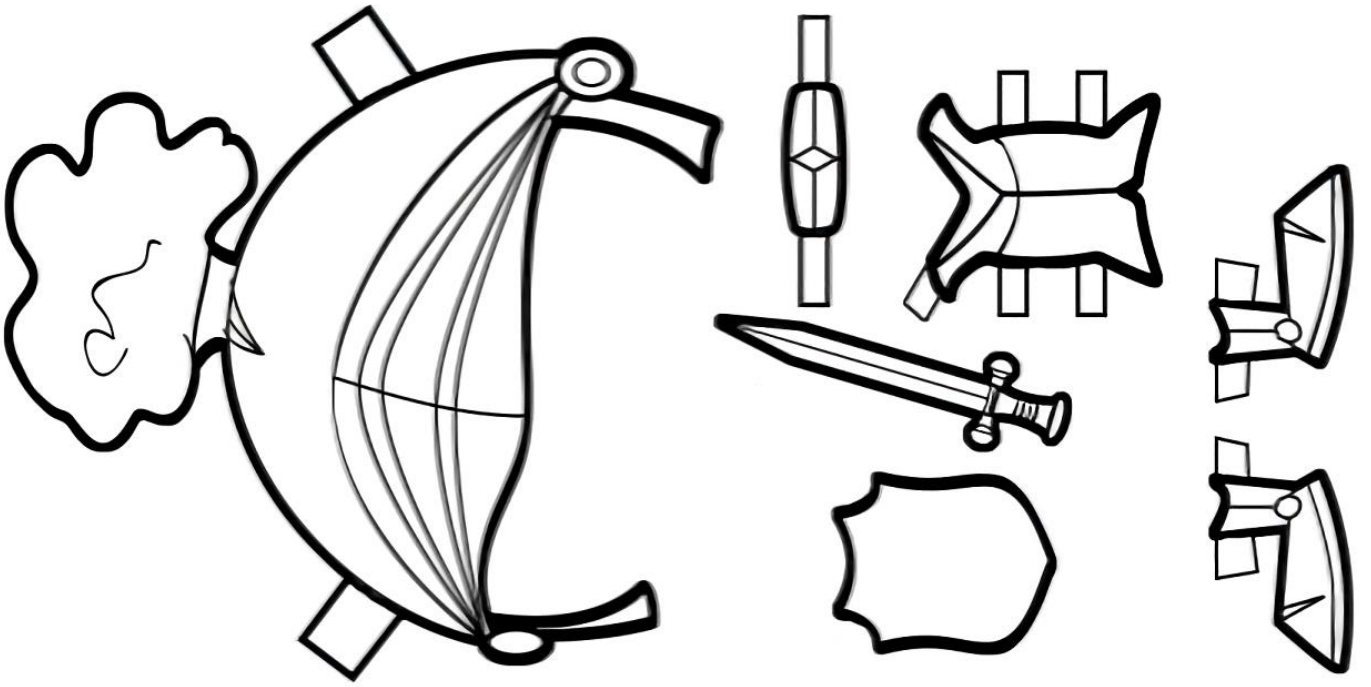

LA ARMADURA ESPIRITUAL

El yelmo de la salvación

- Agradezca a Dios por ser su hijo.
- Alabe a Dios por su vida eterna.
- Posea la mente de cristo.

La coraza de justicia

- Pida a Dios que examine su corazón.
- Confiese todo pecado.
- Posea la justicia de cristo.

El cinturón de la verdad

- Sea veraz.
- Aférrese a la verdad.
- Domine sus sentimientos.



La espada del espíritu

- Empuñe la palabra.
- Permita que el espíritu use la palabra.
- Ore basándose en la palabra

El escudo de la FE

- Haga suya la victoria.
- Avance con fe.
- Apague los dardos del maligno.

El calzado

- El evangelio de la paz
- Este siempre preparado.
- Comparta el evangelio.
- Interceda por los perdidos.